

Mixed Materials Solutions: Alternative Materials for Door Assemblies

Prepared In Conjunction With:

Coalition for Automotive Lightweight Materials

Prepared by:



3005 Boardwalk, Ste. 200
Ann Arbor, MI 48108

Mark Stevens
Shashank Modi
Matthew Chess

August 2016

The statements, findings, and conclusions herein are those of the authors and do not necessarily reflect the views of the project sponsor companies.

Contents

List of Figures & Tables	ii
Introduction / Overview – Mixed-Material Collaboration	1
Collaborative Approach	2
Outcome	2
Fuel Economy Regulation Impact on Mass Reduction.....	4
Regulation Overview	4
Impact of Regulations on Mass Reduction	5
Efforts of OEMs	6
Powertrain	7
Unsprung Mass and Chassis	7
Mass Reduction: Body-In-White	7
Mixed Materials Overview	8
Closures.....	8
EPA Baseline Study.....	9
Overview and Scope	9
Results.....	10
Weights - Estimating and Quick Comparison Approximation Model	10
Enablers	12
Crash Intrusion Beam and Beltline Reinforcement Material Alternatives	13
Outer Panel Steel Developments	14
Curvilinear Laser Welded Blanks.....	15
Paint Systems for Mixed Materials	16
Bonding and Adhesives for Mixed Materials	17
Potential Applications for Composites	19
Liquid Applied Sound Deadener	19
Aluminum Forming Developments	20
Structural Adhesives	21
Mechanical Bonding and Clinching for Mixed Materials	22
Surface Treatments and Sealers for Mixed Materials	22
Carbon Fiber Developments for Industry	23
Composite Forming Developments	24
Structural Foam	29
Advanced Considerations	31

Thermoplastic Sealed Door.....	31
Polycarbonate Glazing	32
Alcoa Micromill™.....	32
Part Consolidation with Curvilinear Welded Blanks	33
Innovation in AHSS	34
Structurally Hybrid Door.....	34
Summary	35
Bibliography	36
Appendix A: Automotive Materials, Applications and Processes	38
Appendix A: Automotive Materials, Applications and Processes (continued)	39
Appendix A: Automotive Materials, Applications and Processes (continued)	40
Appendix B: Coalition for Automotive Lightweight Materials - Contributors	41
Appendix B: Coalition for Automotive Lightweight Materials – Contributors (continued)	42

List of Figures & Tables

Figure 1: CALM Co-Development Team	1
Figure 2: Corporate Average Fuel Economy Requirement and Actual for Passenger Car and Light Duty Truck.....	4
Figure 3: Vehicle Mass in Response to CAFE	6
Figure 4: ZF-9-Speed Transmission	7
Figure 5a: EPA Study Cover Page	9
Figure 5b: 2011 Silverado Door in FEA Mesh	9
Figure 6: 2011 Silverado Door Separated into 5 Significant Components	9
Figure 7: Performance Criteria of the EPA Study	10
Figure 8: Weight Approximation Model, Steel Door Outer (Baseline)	11
Figure 9: Weight Approximation Model, Aluminum Door Outer	11
Figure 10: Weight Approximation Model, Composite Door Outer	12
Figure 11: Baseline Door Assembly: Weight, Grade and Gage	13
Figure 12a: Side Impact Beam Material Change	13
Figure 12b: Belt Outer Reinforcement Material Change	14
Figure 13: Door Weight from 5 Parts Based on Material (base,ST,ST,ST,ST)	14
Figure 14: Door Outer Material Change	15
Figure 15: Curvilinear Weld Line Compared to Standard Weld Line	15
Figure 16: Door Weight From 5 Parts Based on Material (ST*,ST,P,ST,ST)	16
Figure 17: Four Layer Treatment for Mixed Material Surfaces	16
Figure 18: Door Weight From 5 Parts Based on Material (EPA Study Results)	17
Figure 19: Automated Application of Structural Adhesives	17
Figure 20: Door Weight From 5 Parts Based on Material (ST,GFRP,ST,ST,ST)	18
Figure 21: Door Weight From 5 Parts Based on Material (Al,GFRP,Al,Al,ST)	19
Figure 22: Applications of Composites in a Liftgate Assembly	19
Figure 23: Automated Application of Liquid Applied Sound Deadener	20
Figure 24: Door Weight From 5 Parts Based on Material (GFRP,GFRP,Al,GFRP,ST)	20
Figure 25: Aluminum Door Inner Manufactured using Hot Forming Technology	21
Figure 26: Structural Adhesives Enabling Mixed Materials	21

Figure 27: Clinching Products Designed for Mixed Materials.....	22
Figure 28: Thin Film Surface Treatment Bath	22
Figure 29: Door Weight From 5 Parts Based on Material (Al,Al,Al,Al,ST)	23
Figure 30: Carbon Fiber Applications Historically	23
Figure 31: Carbon Fiber Spindles	24
Figure 32: A-SMC Components Formed in Less than 2 Minutes	24
Figure 33: Door Weight From 5 Parts Based on Material (Cont. CF,GFRP,Al,GFRP,ST)	25
Figure 34: High-Pressure RTM/LCM Process' Continued Reduction in Cycle Times	25
Figure 35: Carbon Fiber Reinforced Polymer Door	26
Figure 36: Carbon Fiber Application Progression (BMW i3)	27
Figure 37: Door Weight From 5 Parts Based on Material (GFRP,CF E-SMC,Al,CF E-SMC,ST)	27
Figure 38: Carbon Fiber Application Expansin (BMW 7-Series)	28
Figure 39: Door Weight From 5 Parts Based on Material (GFRP,Cont. CF,Al,CF E-SMC,ST)	28
Figure 40: CFRP A-Pillar Insert Supported by Injected Structural Adhesive (Dow BETAFORCE™)	29
Figure 41: Structural Foam (Dow BETAFOAM™)	29
Figure 42: Four Enablers Integrate into a Single Assembly	30
Figure 43: Door Weight from 5 Parts Based on Material (Cont. CF,Cont. CF,Al,CF E-SMC,ST).....	30
Figure 44: Thermoplastic Sealed Door Module (Advanced Consideration)	31
Figure 45: Polycarbonate Glazing (Advanced Consideration)	32
Figure 46: Alcoa Micromill™ (Advanced Consideration)	32
Figure 47: Novelis Advanz 7000-Series Aluminum (Advanced Consideration)	33
Figure 48: Curvilinear Laser Welded Blanks (Advanced Consideration)	33
Figure 49: Advancement in AHSS	34
Figure 50a: Structural Hybrid Door Inner (Advanced Consideration)	34
Figure 50b: Structural Hybrid Door Inner (Advanced Consideration)	35
Figure 51: The Results	35

Introduction / Overview – Mixed-Material Collaboration: Concepts for Reducing Mass of Next Generation Closures

Automakers are making significant strides and continue serious ongoing efforts to remove additional weight from upcoming vehicles. In response to ever more challenging regulations from the Environmental Protection Agency (EPA), automakers will rely on lightweighting to continue to meet the established goals.

A Co-Development subgroup of CAR's Coalition for Automotive Lightweight Materials ([CALM](#)) working group has collaborated on a project resulting in this report and accompanying presentation which, seeks to lower the weight of a known vehicle door assembly by examining advanced mixed-material and process solutions.

The objective of this collaborative project was to convene suppliers from the CALM working group representing the lightweighting value chain to demonstrate and accelerate the introduction of new lightweighting technologies available for next generation vehicles. The collaborative work represented in this report aims to identify mixed material solutions to reduce weight in future vehicle assemblies by providing technical solutions with results exceeding an established baseline solution, and by linking enabling process technologies with multi-material solutions. This report summarizes the investigation and research work of CALM, and in particular a subgroup comprised of representatives from twenty-three participating companies along with the support of the CALM Steering Committee.

Figure 1: CALM Co-Development Team



This report will briefly summarize the regulations for fuel economy and emissions driving the need for weight reduction in the body-in-white structure and closures of new cars and light trucks. Much has been written and published concerning these regulations, so this report will only reference the current levels of performance and the targets for 2025 as they exist today. All automakers are underway with various, serious efforts to remove weight from their upcoming vehicles, as each seeks to make significant strides toward these very challenging goals.

Collaborative Approach

This effort put forth by a cross-functional team of partners and potential competitors, joining together to provide the industry leading edge technologies, is a unique collaborative effort to provide innovative mixed material solutions to the manufacturers. This team represents those companies that participated together on the development of the solutions shown in this report. They met on a regular basis for a period over a year. Each member company had representatives who participated with the brainstorming of ideas, calculations and debate of merit, and the preparation and editing of presentation materials to bring to OEMs, demonstrating the potential weight savings available with mixed material solutions. A Steering Committee of the Aluminum Association, (Drive Aluminum), the American Chemistry Council, (ACC), and the Management Team at CAR provided guidance and counsel as the project developed. The individual companies having similar technologies for any idea are acknowledged with each example.

The role of the participating companies went beyond submitting ideas for consideration. This team collectively looked into more than fifty potential enablers, each with the goal of providing weight savings when applied to future development. Although each participant may or may not have been the source of any particular idea, the entire team worked together as a unit to evaluate the merits of each idea, along with the associated processes required for potential application. As a result of this rigorous process, the list of potential ideas was reduced to a dozen key combinations for the current term, all of which are available to the industry today. These scenarios represent multiple concepts, each capable of being implemented today without need for extensive additional research and development. Examples of similar applications are used to demonstrate the idea to validate its feasibility and readiness. The potential barriers to implementing weight reduction solutions are also noted, with examples of successful applications demonstrated.

The group also developed a quick assessment tool to analyze the potential weight reductions possible with a change in base material, material grade or thickness. Although only a first step, it provides a rough analysis to quickly determine whether particular substitution solutions are worth pursuing further. The assessment tool will be shown, along with examples of how it is used.

Finally, the team considered a number of future concepts, requiring direct work with an OEM for further development. Examples of some of these are grouped together at the conclusion of the paper.

Outcome

Through this unique collaboration of suppliers, the team of suppliers has completed a project that looks beyond the current published state-of-art, based mostly on monolithic material assemblies and further intends to demonstrate and provide alternative solutions capable of being applied to vehicles currently in development, without requiring extensive research and development efforts.

The final outcome of this initiative is intended to showcase state-of-the-art technologies and to increase understanding and effectiveness how to best implement advanced lightweighting technologies while preserving baseline vehicle specifications. The door assembly is intended as a surrogate to demonstrate multi-material solutions which could be applied to other closures or even other areas of next generation vehicles. These solutions, while primarily targeted and measured as door assembly systems, would apply

to other closure systems in vehicles, whether they be cars or trucks. Doors, decklids, liftgates, and hood systems are all targeted assemblies where the solutions described could bring mass reduction, part consolidation and optimization benefits.

Presentations are being scheduled with individual automakers to share the results and to review opportunities for their own future development considerations.

Fuel Economy Regulation Impact on Mass Reduction

Regulation Overview

Recent changes to federal automotive Green House Gas (GHG) and fuel economy legislation will have a significant impact on the design of the automobile. Corporate average fuel economy (CAFE) was first enacted by congress in 1975 as a policy to increase fuel economy of passenger cars and light-duty trucks. When initially enacted, model year (MY) 1978 passenger cars were required to meet a CAFE of 18 miles per gallon (MPG). By MY 1985, the required CAFE had risen to 27.5 MPG for passenger cars and 19.5 MPG for light duty trucks. From MY 1985 to MY 2010 there had been no increases in the passenger car CAFE. Meanwhile, light duty truck CAFE requirements have increased to 23.5 MPG. The first major increase for both passenger cars and light duty trucks started in MY 2011 and is regulated to increase through MY 2025 at which point the projected required CAFE will be approximately 54.5 MPG. Figure 2 shows CAFE requirements and fleet performance.

Figure 2: Corporate Average Fuel Economy Requirement and Actual for Passenger Car and Light Duty Truck

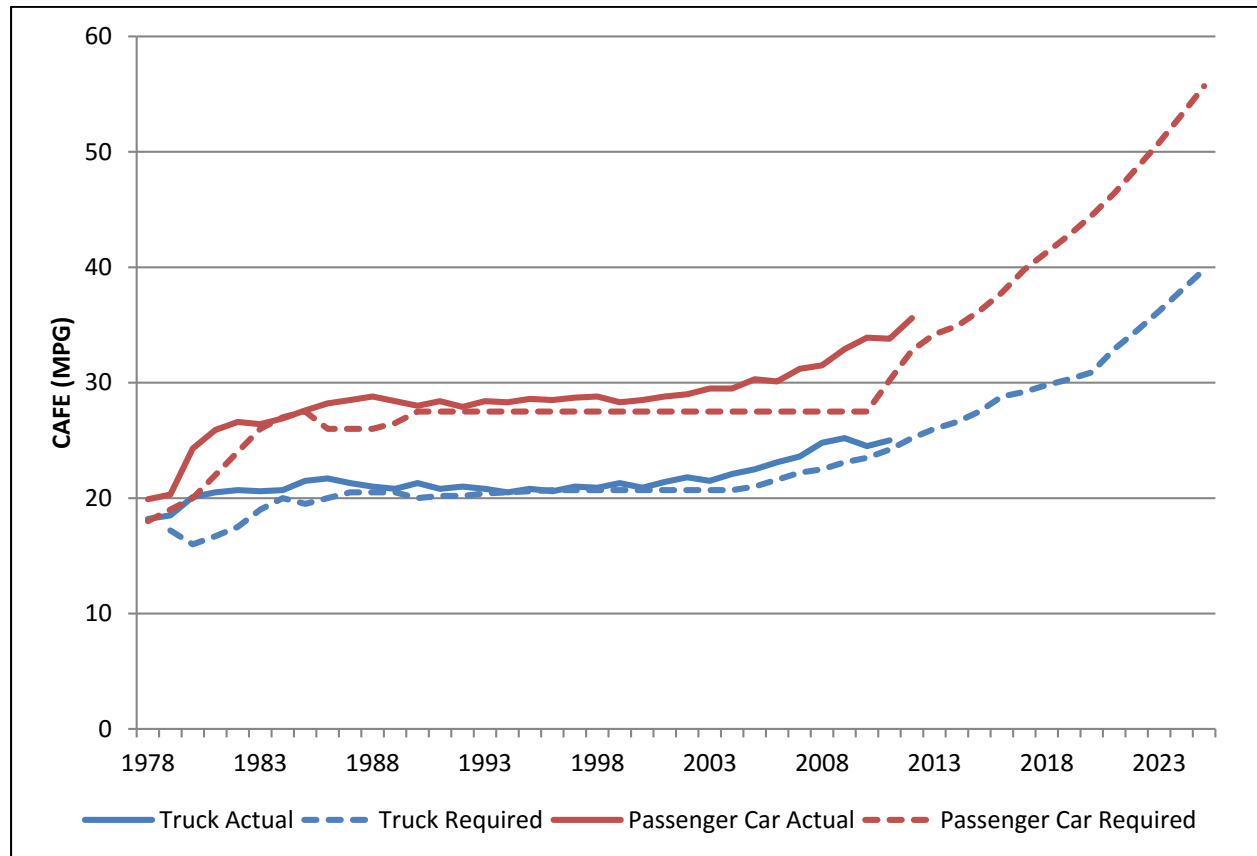

Source: U.S. Department of Energy

The coming rate of change has only occurred once in the regulations history—during the initial implementation period of the regulations (1978-1984). It is worth noting the domestic automotive industry markedly lost market share during that period. Most observers directly attribute that share

decline to difficulties in designing, engineering, manufacturing, and even marketing vehicles that were significantly different than pre-regulation.

The current increase in CAFE has already had an impact on the fuel economy of vehicles. As shown in Figure 3, both passenger car and light duty truck have increased CAFE to meet new federal requirements. As the regulations continue to rise, automakers will need to find more aggressive methods to increase fuel economy.

Impact of Regulations on Mass Reduction

As GHG and CAFE requirements increase, automotive fuel-saving technology will continue to increase through incremental steps, but there will also be opportunity for more transformational changes. Improvements are expected to powertrain technology, lightweighting, aerodynamics, and frictional losses to meet the proposed requirements.

Vehicle lightweighting is poised to increase in significance as fuel economy requirements become more stringent. A reduction in vehicle mass by 10 percent is estimated to improve fuel economy by as much as 6 to 8 percent. Vehicle lightweighting is a well-known and proven method to improving fuel economy.

The industry's acceptance of lightweighting to improve fuel economy is well known. At the time CAFE was enacted, the industry went through a significant overhaul in terms of vehicle design. In fact, the most significant reduction in vehicle mass over the past 40 years was in response to the initial CAFE legislation of the late 1970s as shown in Figure 3 when unibody structures were substituted for body-on-frame designs.

Figure 3: Vehicle Mass in Response to CAFE

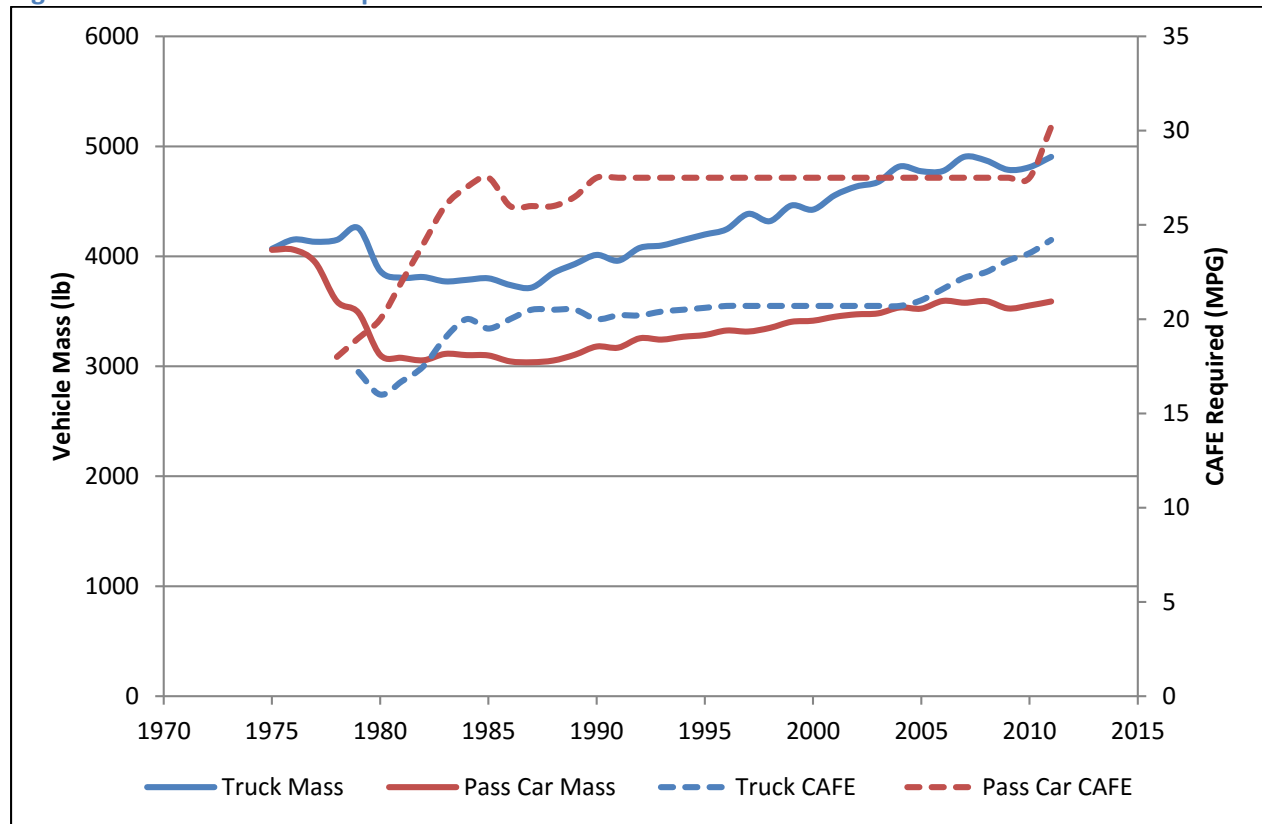

Source: U.S. Department of Energy

Appendix A shows different grades, alloys or types for the aluminum, composites, magnesium, and steel that are used in current passenger cars and light trucks. It also shows the common automotive applications, and the processes used to create those components.

Efforts of OEMs

Three Targeted Areas to Meet Regulations

All OEMs in the automotive industry have been increasingly aggressive in efforts to meet the regulations taking effect through 2025. Of special note for this paper are the demands of the looming regulations that are driving acceleration in the OEM weight-reduction initiatives. Over the years, all OEMs sought weight reduction for a variety of competitive reasons to offset additional weight added for safety performance, improve MPG performance among competitors in any weight class, or to improve basic vehicle performance, considering handling, acceleration, braking, etc.

As shown in Figure 3, the mass of trucks and cars has steadily increased since the mid-1980s as a direct result of OEMs implementing measures to meet the increasing safety requirements. Side impact door beams, high strength and heavier windshield frames and roof headers are all examples of weight additions for passenger protection to meet regulations.

The efforts to date of all OEMs to meet fuel economy regulations fall into one of three natural groupings: Powertrain, Chassis, and Body-In-White.

Powertrain, representing the engine and transmission of the vehicle, has gone through the most sophisticated rework in any industry. What was typically regarded as a basic internal combustion engine, described in cubic inch size and typically developed in 8, 6, or 4 cylinders, has radically changed to keep pace with competitive demands of the marketplace and regulations. Many papers have been published over the years describing the various technology changes applied to engines, as fuel injectors replaced carburetors; turbo-chargers and super-chargers enabled the reduction in engine displacement while preserving performance; and transmissions grew from basic 3-speed automatics to complex mechanisms of 7-, 8-, and even 9- and 10- gears. See Figure 4 for an example of a 9-speed transmission. Cast iron engine blocks were replaced by cast aluminum. Continuously variable transmissions are now finding their way into the market to go beyond the performance of multi-speed gearboxes. The powertrain itself is being redefined with hybrid powerplants, plug-in hybrids and fully-electric vehicles.

Figure 4: ZF-9-Speed Transmission

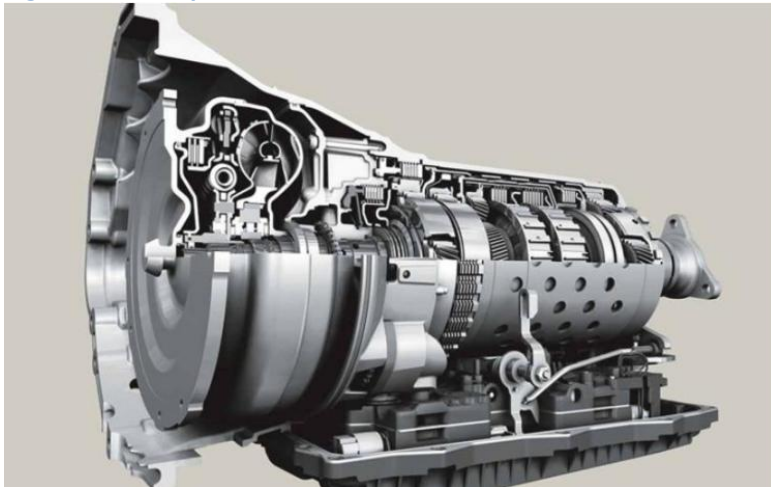

Source: Center for Automotive Research / ZF

Suspension components comprise most of the unsprung mass of vehicles, and bring the challenge of reducing the weight to reduce drag on performance. This has brought a wholesale change from cast iron and steel to cast, extruded and wrought aluminum to remove excess weight while preserving the overall performance of the fleet of cars or light trucks on the road.

The body-in-white and closure panels are the third focus area for weight reduction, and are the focus of this paper. A long list of newly developed materials are available for use in the welded auto bodies produced today and in the future. Many enablers, to be described in this paper, are being implemented to resolve potential roadblocks to the mixing of the use of multiple materials in the body construction. New welding, adhesive, and fastener technologies are just a few examples of the technologies serving as enablers for this transition of materials. The body-in-white remains the largest opportunity for significant weight reduction.

While it is apparent no automotive company will attain the goals by focusing on only the body-in-white, or only the powertrain or chassis, it is clear that all the OEMs in the auto industry are picking up the pace of reducing weight in the bodies of their new vehicles, in their efforts to meet the challenging regulations. The pathways being taken by every automaker may vary somewhat between companies, but every company includes removing weight from the body-in-white and closures as part of its overall strategy.

Closures represents a significant opportunity for weight reduction. Unlike the balance of the vehicle body, the closure assemblies are mounted after body assembly. Closure assemblies include doors, liftgates, decklids and hoods. These are able to be built up off-line, and bolted on to the assembled body. This overall process sequence enables the closures to be made of entirely different base materials than the essential car body structure.

It is very common today to see a generally mild-steel automotive body of welded construction, with an aluminum hood assembly bolted on through the hinge system. This reduces weight over the engine, and improves overall vehicle performance along with improved fuel economy from the lighter overall mass of the final assembled vehicle.

There have been examples of magnesium liftgates and/or decklid assemblies applied to an otherwise mild-steel automotive body. This dramatically reduces the weight of the overhanging mass of the rear of the vehicle, enabling improved vehicle balance and an overall improvement in vehicle performance.

While there are opportunities to replace any closure system with alternative, lighter weight materials, the inherent barriers to mixed materials all need to be addressed in order for the alternative material to be successful in its application. In the aforementioned magnesium example, adequate corrosion protection is mandatory. The dissimilar metals need to be isolated from coming into contact, especially in an area open to moisture. The dissimilar materials contacting each other promote galvanic corrosion, as seen in a metal flashlight where old batteries were left in place far after their useful life. If that flashlight was stored in the basement, the moisture would be enough to initiate the corrosion.

One additional reason many OEMs apply their weight savings initiatives to closure assemblies first is the opportunity to gain additional weight savings opportunities from the effort. If an OEM applies a lightweight liftgate assembly, then the struts used to hold it in the open position can be lighter. The electric motors used to power it open can also be lighter duty. There is a recent example where the liftgate was light enough to eliminate the power option completely, and rely only on torsion bars to provide power for opening the gate. As the vehicle becomes lighter due to all the closure assemblies being reduced, the vehicle no longer requires the same size of engine, brakes, shock absorbers and struts to provide similar operational performance.

EPA Baseline Study

As a starting point, and baseline the CALM co-development team, (hereafter referred to just as the Team), used a recent EPA sanctioned study report (completed by FEV). Refer to Figures 5a and 5b.

Figure 5a: EPA Study Cover Page

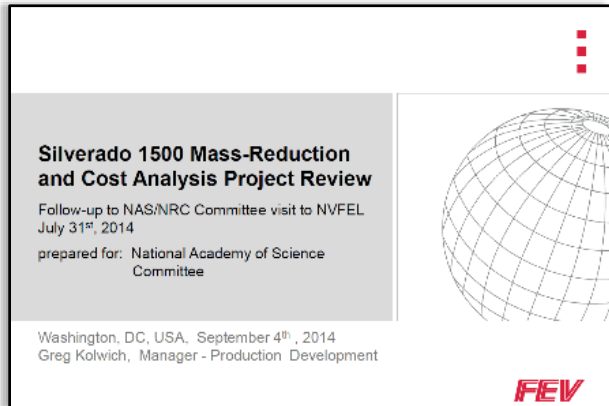
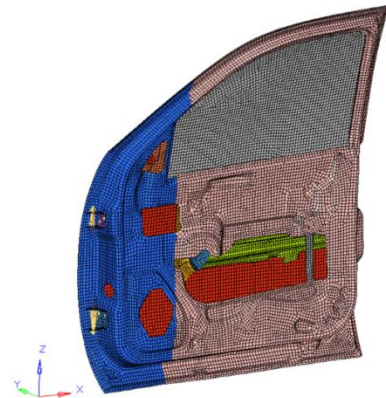

Figure 5b: 2011 Silverado Door in FEA Mesh



This report, published mid-year in 2014, studied the potential weight savings capable at that time, using a 2011 Chevrolet Silverado as a surrogate example. This study explained alternative construction strategies, and showed significant weight reduction was possible, with the result focused on substituting sheet aluminum in place of mild-steel panels for the door inner and outer panels.

A significant finding in the study is 80 percent of the weight of the closure assemblies were contained in only five of the components. This provided additional focus for the CALM team study, to ensure time was spent looking into those components that would make the most difference to the final weight, limiting the time spent studying those items with little potential.

Figure 6: 2011 Silverado Door Separated into 5 Significant Components

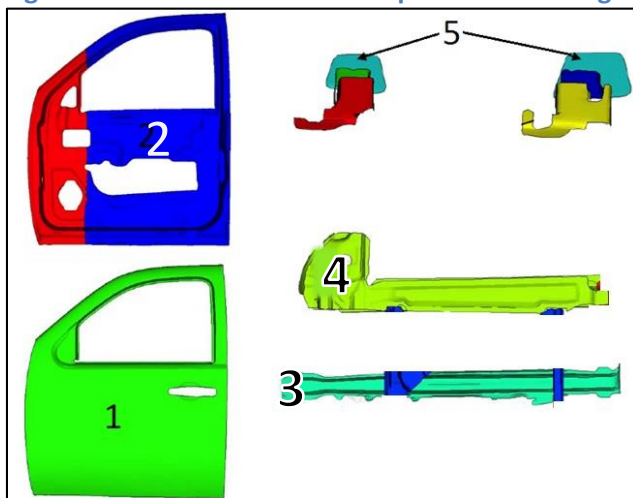

These five components formed the basis of the study by the team. The five parts on the original Silverado represented 29 kgs of mass. Having all the math, performance criteria, and results of the EPA

study enabled the work to continue at a good pace. These parts, materials, and related processes all represented the expertise of the Team, more reason to focus the study on these parts. In all of the more than 20 combinations studied, the panels are always referred to in the same order:

1. Door Outer	9.2 kgs
2. Door Inner	14.5 kgs
3. Crash Intrusion Beam	2.5 kgs
4. Beltline Reinforcement	2.1 kgs
5. Hinges	0.7 kgs

The performance criteria for the door assembly was described in detail inside the EPA report, with the key attributes shown in Figure 7 below. The overall intent of the efforts of the Team was to limit recommendations to those where the expected performance of the assembly would adhere to the stated criteria without degradation. Although any new development of a new door assembly using the recommendations shown in this report would require full finite element analysis and prototypes along with physical testing, the Team limited suggestions where more basic calculations were used to show fundamental characteristics, such as stiffness, were preserved, even if it meant increasing the gage or thickness of a panel as the material or grade was changed.

The results of the EPA-sanctioned report provided an aluminum intensive solution using readily available aluminum gage and grades of material, and reduced the original 29 kgs mass to 18.8 kgs. The Team took this as its starting point and benchmark, with the intent to provide solutions using existing materials and processes to reduce the assembly weight further, driving the total mass below the 18.8 kgs benchmark.

Figure 7: Performance Criteria of the EPA Study

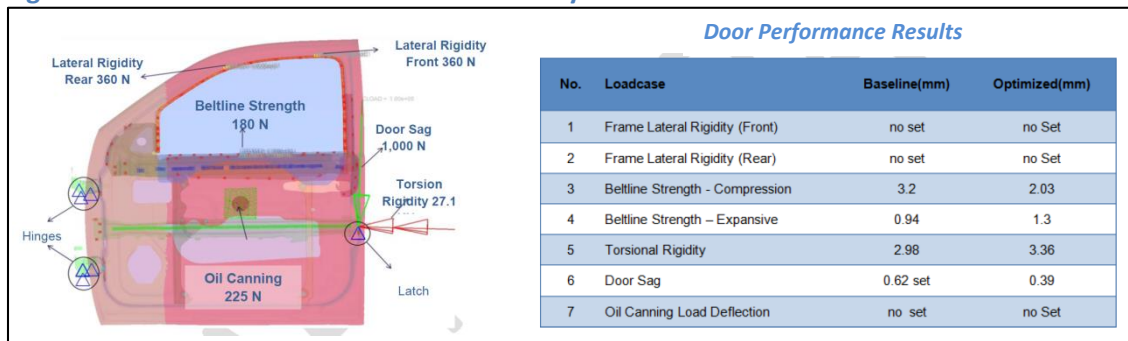

Source: EPA 2014 Review

Weights – Estimating and Quick Comparison Approxim

Comparing material options is typically a time-consuming process with a large variety of variables to consider. Finite element analysis and physical prototyping is naturally required to understand the effective gage and material grade/blend for the loads endured by specific components. CAR researchers recognize the need for quick assessment of material substitutions and have developed a “Weight Approximation Model”, an analysis tool which was used, specifically, for four components (not the hinges) of the 2011 Silverado door. Three variables are used in this model including gage, material grade/blend and the resulting mass of the component. Any two of the three mentioned variables may

be manipulated to output the third. A wide variety of steel, aluminum and composite options are available for comparison. A baseline example of the Weight Approximation Model was selected, shown in Figure 8 below. In this example a 0.7 mm gage and SAE 1025 grade steel was selected for the door outer component, which resulted in a mass of 6.362 kg.

Figure 8: Weight Approximation Model, Steel Door Outer (4 components)

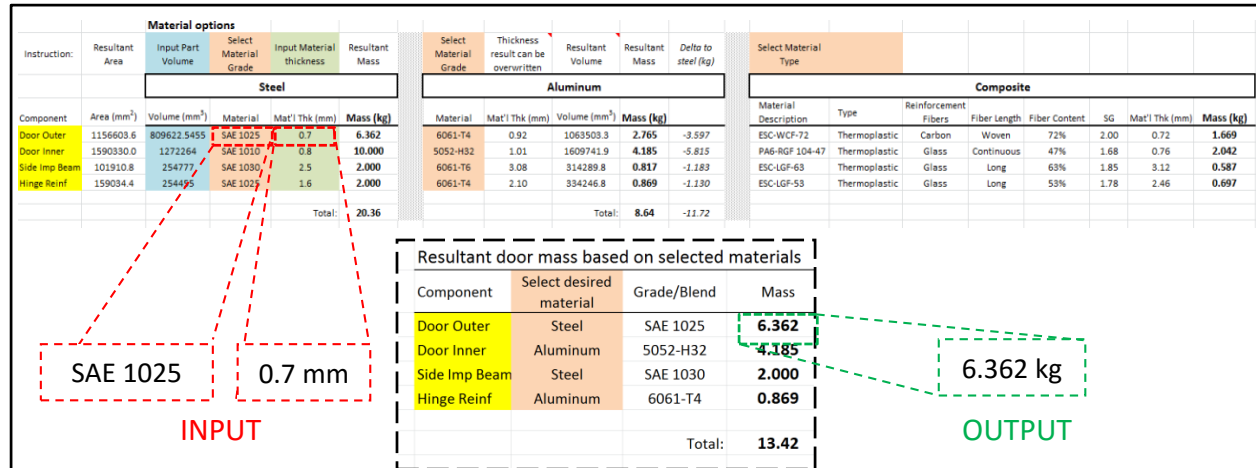

The capabilities of the Weight Approximation Model can now be exemplified when substituting the SAE 1025 steel door outer with 6061-T6 aluminum, seen in Figure 9. By simply selecting the desired blend of aluminum from a drop down menu, a new gage of 0.89 mm is automatically generated. This new gage is calculated using an algorithm relating the strength of the new aluminum blend to that of the original steel grade. This algorithm ensures similar performance of the new material to the baseline. The new gage value is used to calculate the resulting mass of the component, which can be easily compared to the original steel component.

Figure 9: Weight Approximation Model, Aluminum Door Outer (4 components)

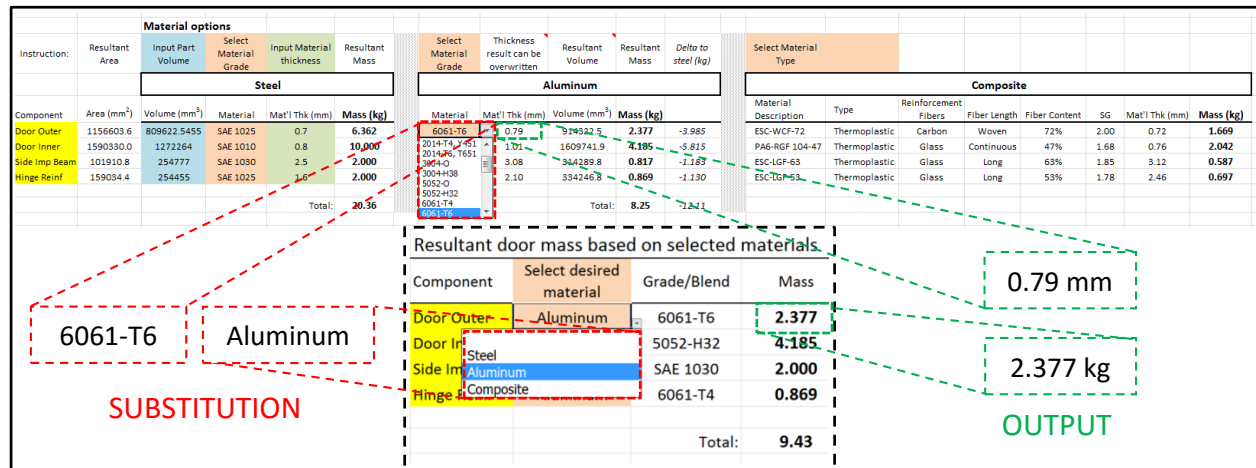

The next example, shown in Figure 10 below, introduces composites. Again, the door outer material is substituted. After selecting ESC-WCF-72 composite from the drop down menu, the approximation model

displays various properties of the composite. In this example, the spreadsheet reveals that ESC-WCF-72 is a woven, carbon fiber thermoplastic material with a fiber content of 72 percent. The model then outputs an appropriate gage for the new component as well as the resulting component weight.

Figure 10: Weight Approximation Model, Composite Door Outer (4 components)

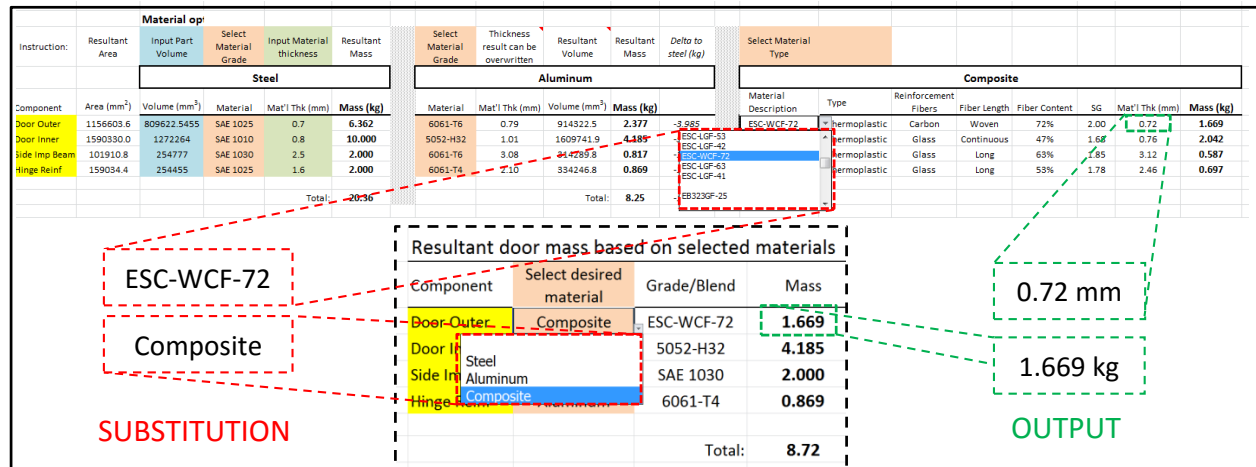

It can be seen that by selecting two options from the spreadsheet, a material substitution may be simply simulated. The CAR development group has used the Weight Approximation Model extensively to provide quick analysis and validation of material options. This quick analysis helps CAR researchers understand which material combinations should be pursued further with more extensive research and development. It should be noted that this approximation model does not eliminate the need for rigorous validation testing using physical prototypes and finite element analysis.

Enablers

In order to offer reasonable solutions to remove weight from future assemblies, the Team needed to evaluate the impact of the long list of ideas. Some of those ideas were discarded by the Team as being too far-reaching, or not currently capable of high quality results. The Team kept a dozen potential solutions, leaning heavily on mixed material solutions. These solutions are presented in the order of the resulting weight, so the assembly weight is always declining with each subsequent idea. As with all the references stated to this point, the Team started with the 29 kgs mass for the five components shown earlier.

It was noted through the working group the various ideas for altering the hinge systems were dismissed, as the group did not have the tools necessary to validate the performance of any change in hinge material or design. Although it is reasonable to expect a door weighing perhaps half the weight of the starting assembly would perform adequately with a lighter set of hinge components, the Team was not comfortable in taking that risk. As a result, the hinges used in every scenario are unchanged from the original design.

To evaluate, the Team started with the baseline of the original door assembly, as released for production. Shown in Figure 11 are the gage and grade maps for that original design. Note the gage, or metal thickness shown, for the door inner panel has two numbers as it was stamped from a laser welded blank. The area of the hinges was designed to be thicker, to eliminate a separate hinge reinforcement to assemble.

Figure 11: Baseline Door Assembly: Weight, Grade and Gage

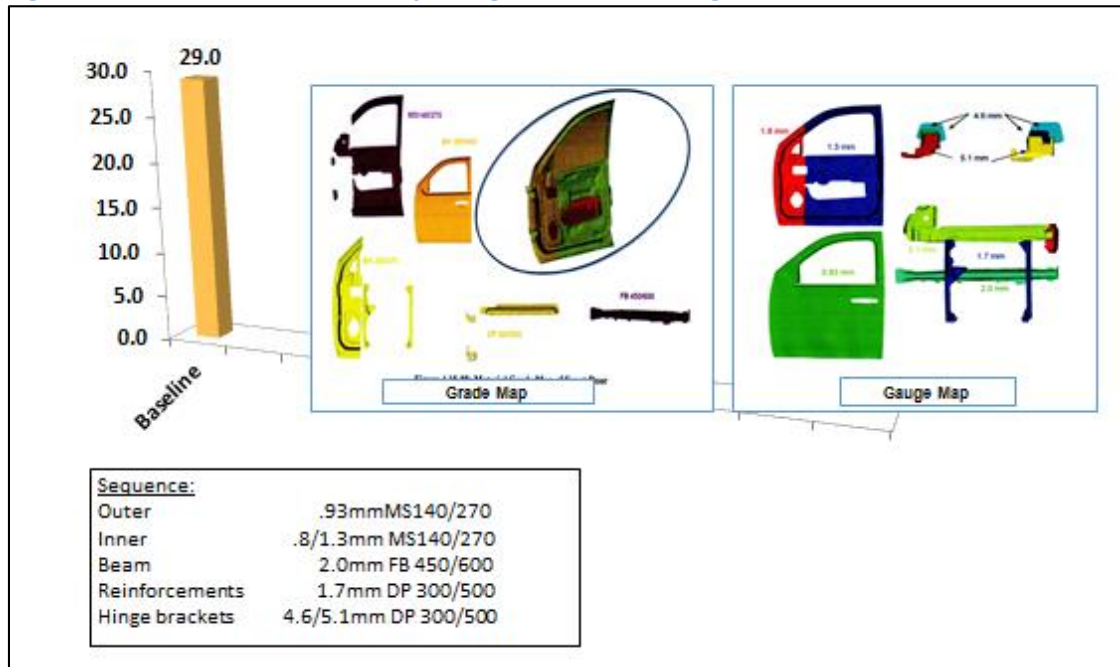

The first recommendation focused on the crash intrusion beam and beltline reinforcement. It was noted by the Team if this door was designed and released today, it would most likely use a press hardened steel crash beam and beltline reinforcement of higher strength steel than what was used in the 2011 Silverado. The basic materials available today are different (stronger) so it was a simple task to show the first recommendation to use the same material and gages typical of current new models released for production. Substituting the ferritic bainite beam for a boron beam, and increasing the beltline reinforcement to a dual phase 980 material from the original design of DP500 reduced the weight for both panels. The individual results for each of these are shown in Figures 12a and 12b below.

Figure 12a: Side Impact Beam Material Change

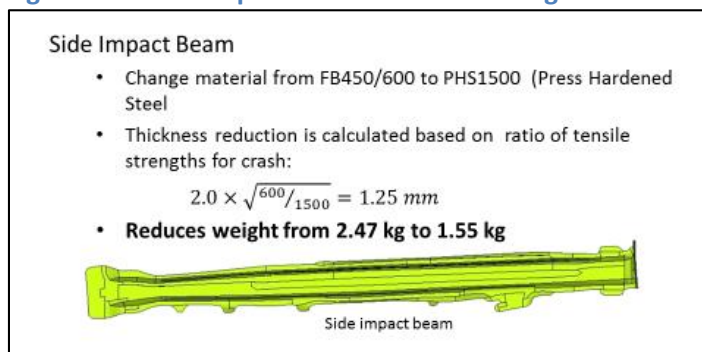
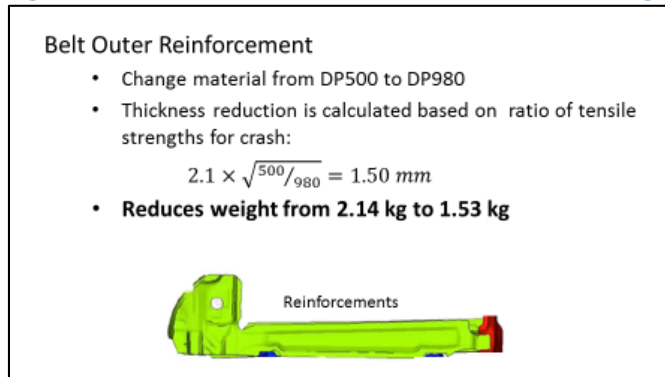
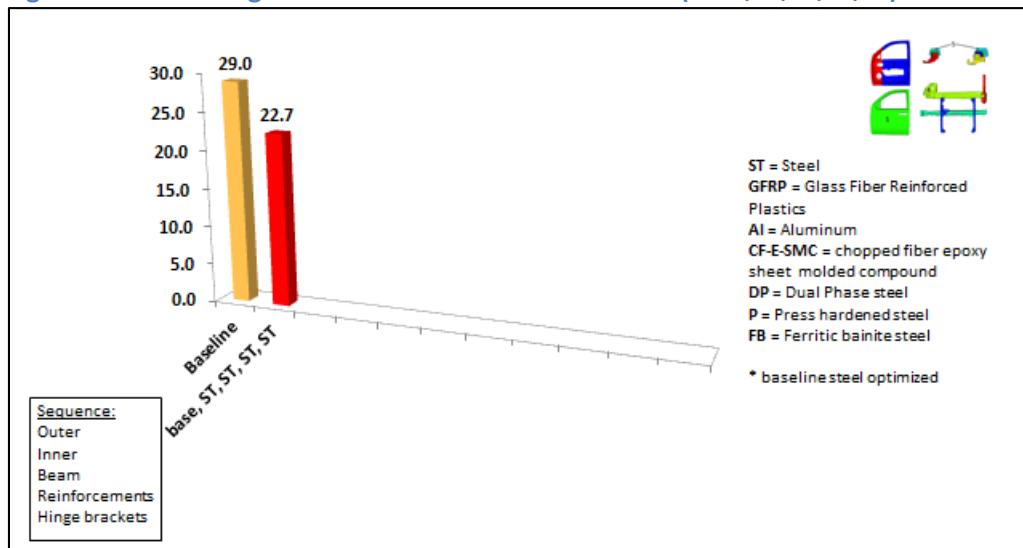

Figure 12b: Belt Outer Reinforcement Material Change



This updating of materials to what is currently typical brings the first result in Figure 13, where the assembly weight drops to below 23 kgs from the original 29 kgs. This Figure explains the abbreviations used throughout the study when describing a door if it was designed for production today. The key shown on the right side of the chart explains the various material grades deployed. This chart translates the abbreviations shown below each bar describing the total weight of the five parts in the assembly.

Figure 13: Door Weight from 5 Parts Based on Material (base,ST,ST,ST,ST)



To go further, the steel representatives on the Team recommended a change to implement a higher strength, dual phase steel. This alternate material, suitable for the outer panel only, results in a thinner gage being possible due to its inherent higher strength. Changing to higher strength dual-phase bake-hardenable material (DP 440 BH) allowed the Team to reduce the weight of the assembly further, dropping the weight of the outer panel to 6.4 kgs from 9.2 kgs. The weight calculator explained earlier derived a new gage of .65mm with this higher strength material, which is in line with what is typically found on current designs.

Figure 14: Door Outer Material Change

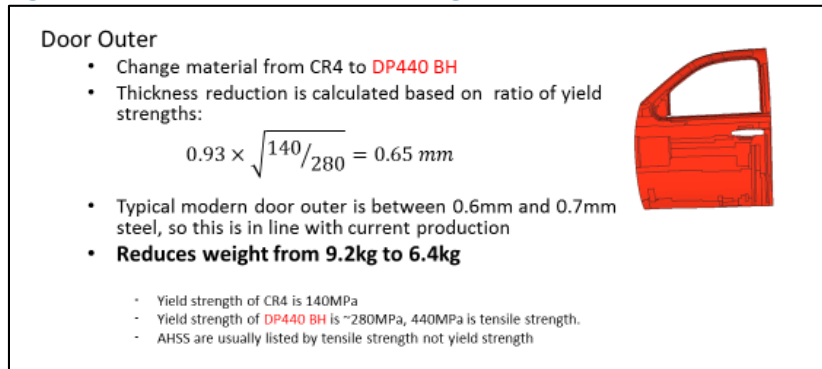

While looking into the gage and grade changes possible in steel, the Team deployed the curvilinear blank outline to reduce the weight of the laser welded blank. This allows the design to have the thicker material only in the specific area of hinges where it is needed, without wasting extra material due to a linear blank joint line. The change in blank outlines can be seen in Figure 15, where front and rear doors are shown on the left with the curvilinear weld lines, while the original, straight weld line is shown on the right.

Figure 15: Curvilinear Weld Line Compared to Standard Weld Line

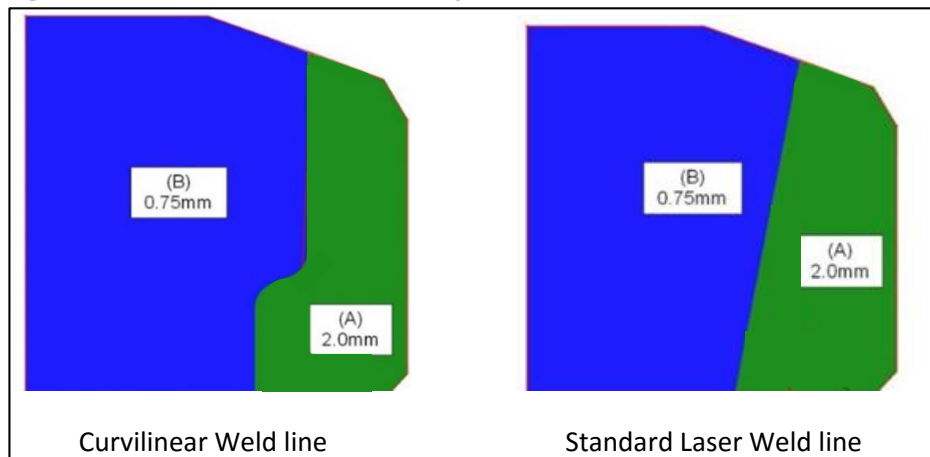

Source: CAR

As shown in Figure 16, combining the curvilinear weld line idea along with the higher strength material for the outer panel further reduces the weight of the resultant assembly to just below 20 kgs. Deploying the curvilinear weld concept accounted for .47 kgs of the weight reduction, and is an attractive concept to deploy in any instance of applicable steel or aluminum laser welded blank material.

Figure 16: Door Weight from 5 Parts Based on Material (ST*,ST,P,ST,ST)

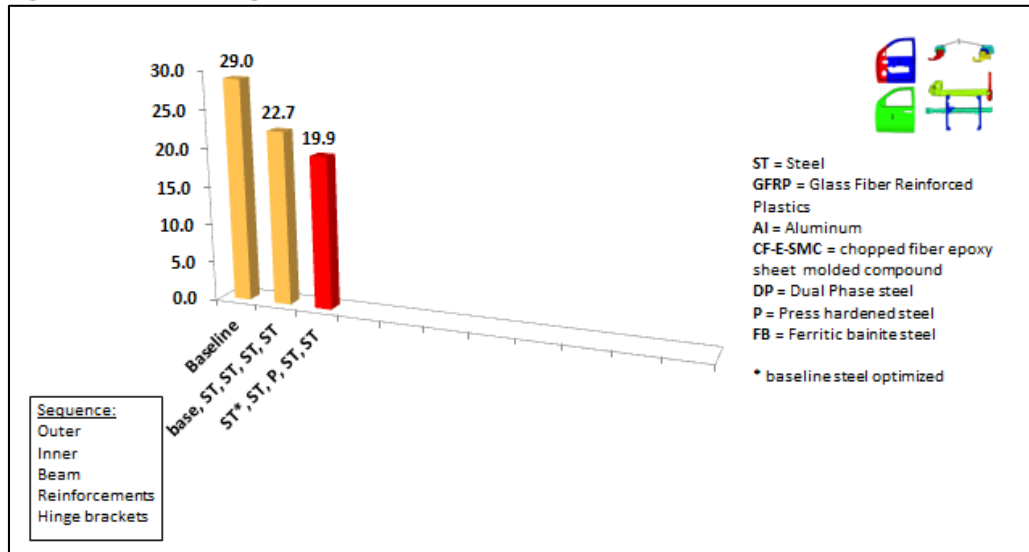

In the effort to go further into weight reduction, the Team analyzed the mixing of materials for the five components in the study. The barrier of the paint shop system needs to be addressed to enable this mixing of materials. Several members of the CALM co-development Team manufacture surface treatments and sealers, all targeting the ability to mix materials in the body shop, while enabling success in the paint systems. One of those examples is shown in Figure 17.

Figure 17: Four Layer Treatment for Mixed Material Surfaces

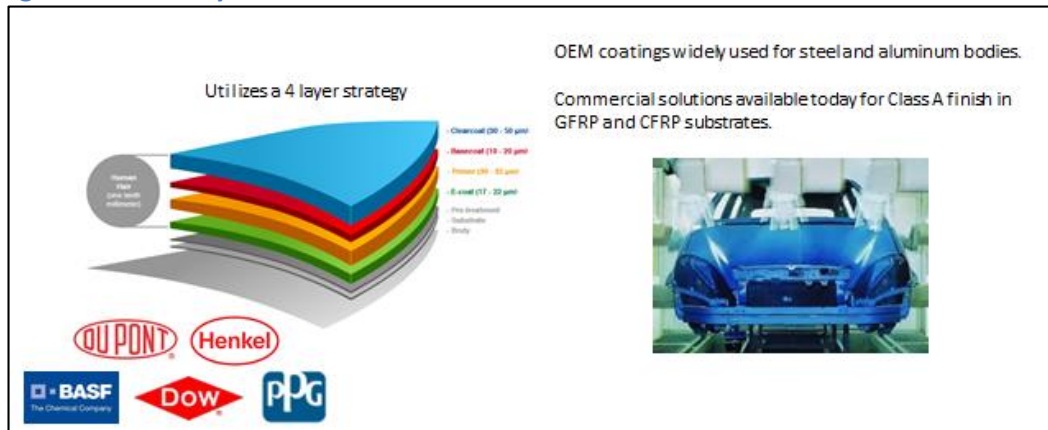

Source: BASF

The baseline for the project effort, as described in the EPA-sanctioned report, featured the use of aluminum sheet for the door inner and outer panels. Since the crash intrusion beam, beltline reinforcement and hinge systems remained steel; this result is also the baseline for a mixed material solution. This solution requires efforts to isolate the differing materials to mitigate galvanic corrosion. The aluminum sheet used in the study was grade 6022 aluminum, bringing the 29 kgs initial door weight down to 18.8 kgs.

The Team plotted this first level of a mixed material door to include in the charting of the overall group efforts. This result is shown in Figure 18.

Figure 18: Door Weight from 5 Parts Based on Material (EPA Study Results)

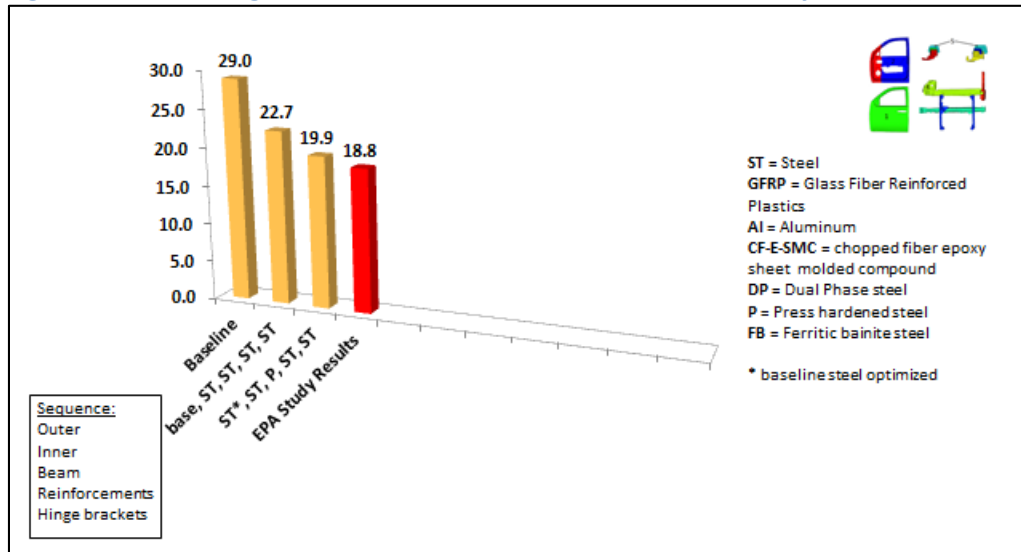

Building on this initial solution of including aluminum and steel, the Team looked into the tools, processes and components available for joining the mixed materials. As is the case with the coatings, several members of the Team produce adhesives to enable simultaneous bonding and isolation. Additionally, the Team recommended the addition of structural adhesives, adding another positive element. While there were various methods looked at for deploying the material inside assembly systems, a simple robotic system is the most prevalent and appropriate for standard volume assembly operations. An example of such a system dispensing adhesive on a door is shown in Figure 19.

Figure 19: Automated Application of Structural Adhesives



Source: CAR

Since the joining, protecting, and isolating of materials addresses many of the barriers to multiple materials, the Team expanded its study to include glass fiber reinforced inner panels. They considered

the manufacturing and assembly operations, and discovered opportunities for combining parts and reducing piece and assembly costs through consolidation.

New glass fiber reinforced composite materials, including the use of reinforced nylon, are now beyond the development phase, and are ready for use in new applications. These materials allow for variation in the percentage of glass reinforcement and also in the weave, to enable addressing directional stiffness, as required. These new materials are electro-coat capable, meaning they can survive the high heat of the primer tanks and bake ovens.

The use of a glass fiber reinforced inner panel further reduced the weight of the assembly, now down to below 18 kgs, as shown in Figure 20.

Figure 20: Door Weight from 5 Parts Based on Material (ST,GFRP,ST,ST,ST)

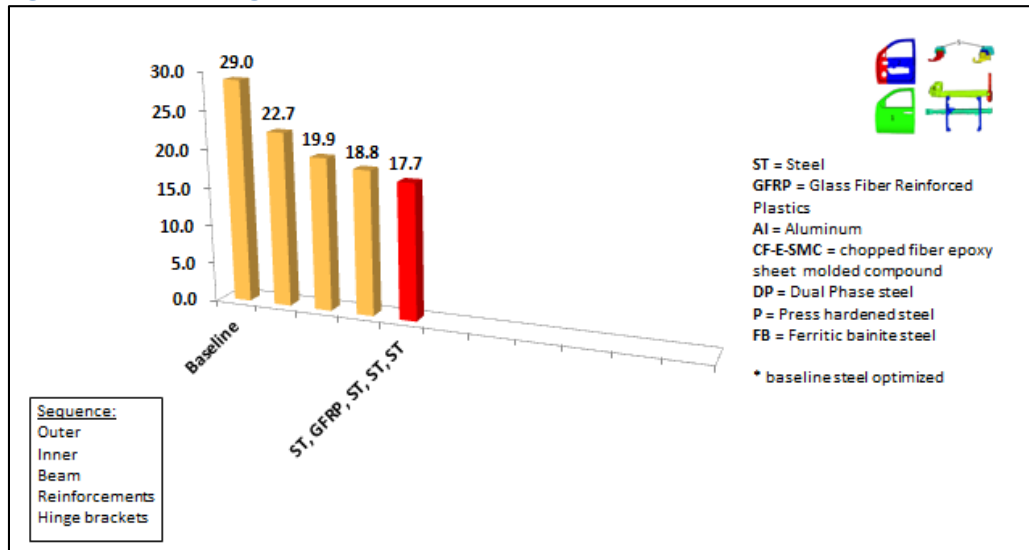

An extruded aluminum impact beam was evaluated. These beams were initially developed and implemented in Europe, and are now available in North America. Changing the beam to aluminum removed another kilogram, or 2.2 pounds, (per door).

Combining the extruded aluminum beam along with a substitution of aluminum for the mild steel outer panel, reduced the weight again, now down to just over 17 kgs, as shown in the following chart.

Figure 21: Door Weight from 5 Parts Based on Material (Al,GFRP,Al,Al,ST)

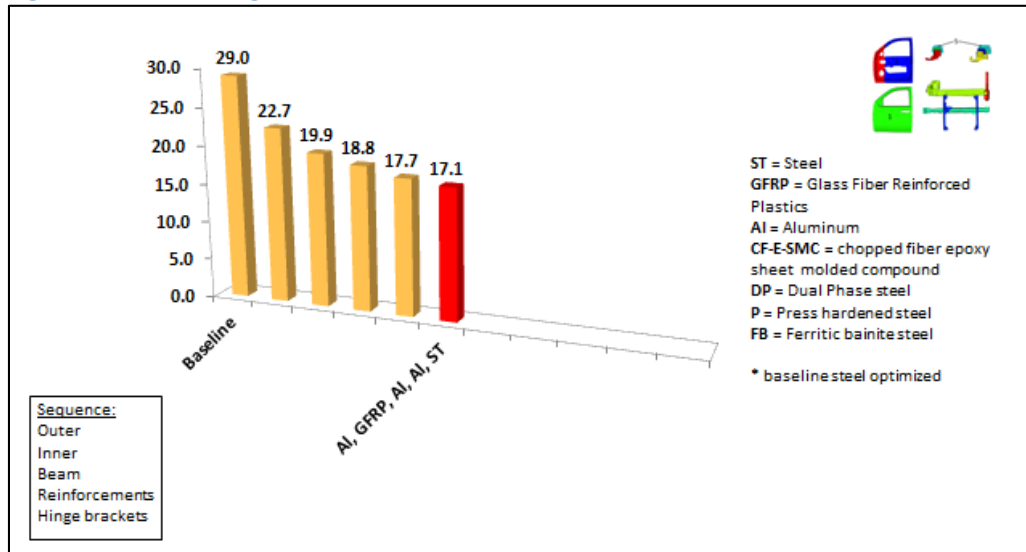

The weight savings opportunities available from a number of various composites were studied by the Team. Examples of combining glass fiber reinforced composites, with sheet molding compounds and other thermoplastics were all examined. Figure 22 demonstrates the variety of solutions possible.

Figure 22: Applications of Composites in a Liftgate Assembly

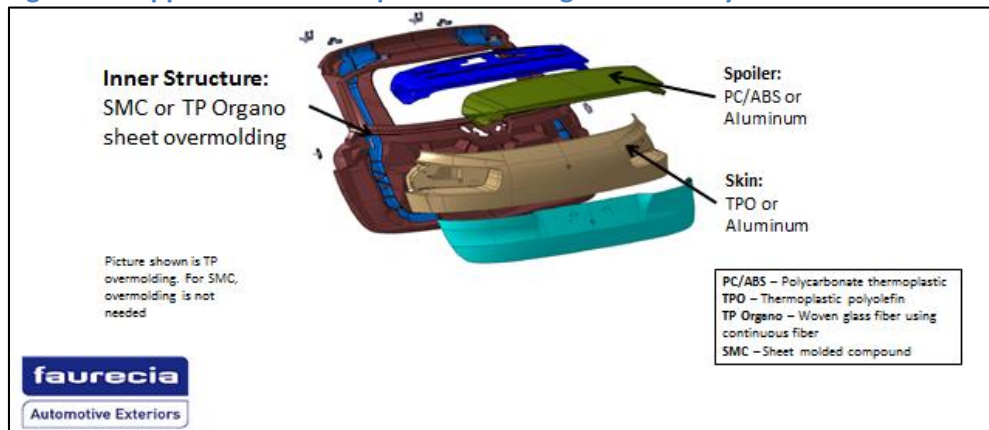

Source: Faurecia

Moving from a metallic outer panel, as designed in steel, or substituted in aluminum, to one of the various composites brings the question of ensuring proper dent resistance and anti-flutter.

Technologies such as liquid applied sound deadener (LASD) are available from several companies, as shown in Figure 23, and are in current production across all OEMs. LASD brings an element of sound deadening to improve acoustics, along with its application for reducing vibration.

Figure 23: Automated Application of Liquid Applied Sound Deadener



Source: Henkel

Increasing the use of glass fiber reinforced polymers to include the door outer and beltline reinforcement drives the weight down to 16.5 kgs, as shown in Figure 24.

Figure 24: Door Weight from 5 Parts Based on Material (GFRP,GFRP,Al,GFRP,ST)

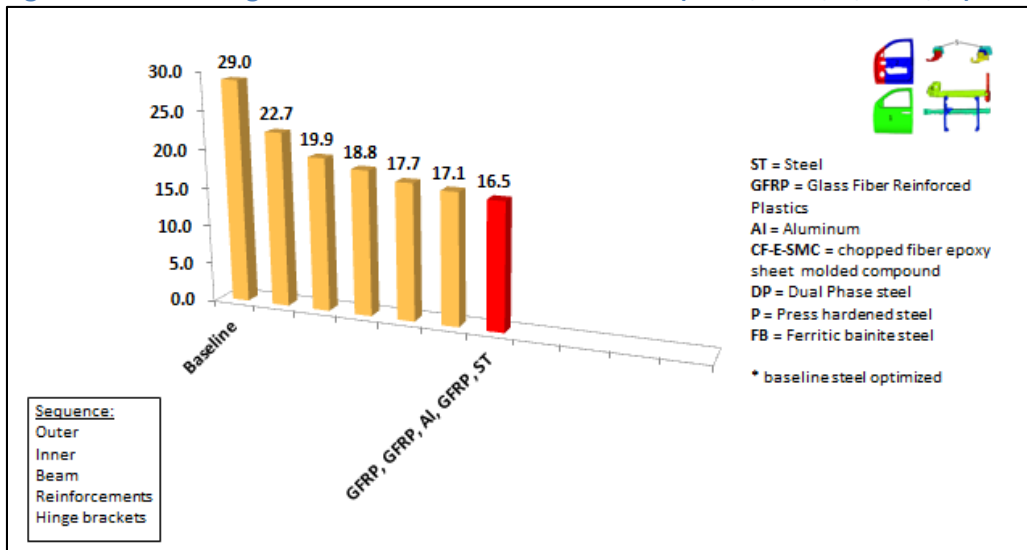

There are additional potential reductions to realize using aluminum. While steel has an inherent capability of being strained to approximately 27 percent, basic aluminum sheet is limited to approximately 20 percent. This reduction in strain capability limits the application to gentler, softer designs, with less depth of draw in the initial forming tool for stamping. This strain limitation can be addressed with the application of heat. AP&T has applied their press hardened steel technology to forming aluminum. Pretreatments are available today to address any oxide formation from the heating

process (enhanced pretreatments also serve as enablers for adhesive application as well as corrosion protection).

Their system allows precise control of temperature, tonnage and time. This precise control capability allows for the application of what the metal forming industry refers to as Warm Forming Aluminum, a process where the aluminum sheet or blank is heated to a precise temperature, then transferred immediately into a forming station. Strains previously limited to near 20 percent have been demonstrated up to 50 percent using this process, eliminating the barrier of strain from the application. An example of warm formed aluminum is shown in Figure 25, and is currently in production in Europe.

Figure 25: Aluminum Door Inner Manufactured using Hot Forming Technology

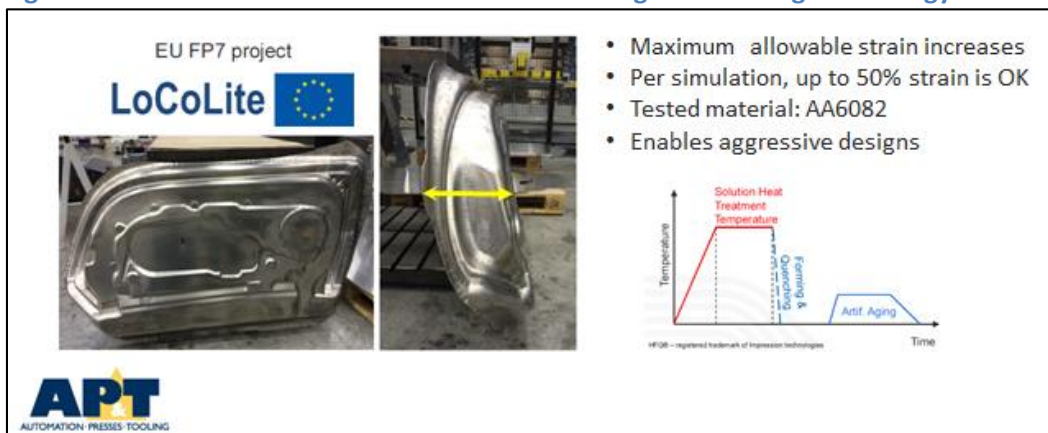

Source: AP&T

The Team demonstrates the material and application process for a structural adhesive shown in Figure 26. The material itself, along with the robotic application process in a continuous bond-line design improves overall stiffness and enables the bonding of aluminum structures. This material and application process are already demonstrated in production, with similar applications and material provided by several CALM companies as shown below.

Figure 26: Structural Adhesives Enabling Mixed Materials



Source: Dow Automotive

Physical fasteners still play a significant role in assembling vehicles of alternative materials. The Team demonstrates an extended line of clinched products, with inherent isolation capability. This isolation helps overcome issues of galvanic corrosion arising from the mixing of materials in assemblies. Since clinch nuts play a significant role in fastener strategies of many auto companies, having alternatives available to apply when materials are mixed enhances the capability to remove weight from the assembly, as shown in Figure 27.

Figure 27: Clinching Products Designed for Mixed Materials



- Studs and nuts from M5 to M12
- Studs with length up to 40 mm
- Material Thickness Range:
- 0.75mm- 12.0 mm
- For aluminum, steel, stainless steel, castings, extrusions, sheets and other applications
- Studs with grades 8.8 – 10.9 – 12.9
- All nuts are grade 10
- Cold formed specials with clinching features





Source: Rifast

Compounding the use of mixed materials drives additional demands into the paint system of the assembly plant. In the earliest applications of alternative materials, the installed paint shop systems acted as barriers to new materials, as the phosphate baths, overall electrocoating process for primer and surface treatment and the paint system itself were finely tuned to one, monolithic material. This initially limited alternative material choices to those panels referred to as “hang-on” components, those parts and sub-assemblies that could be bolted on in assembly post paint shop.

In today’s modern paint shops, CALM supplier companies produce thin film treatments that can protect and survive the e-coat and paint process, further enabling the use the multiple material solutions. This addresses and removes those barriers limiting application to bolt-on solutions. We see an example of this shown in Figure 28.

Figure 28: Thin Film Surface Treatment Bath

- Thin film surface treatments enable multi-material solutions
- Improves process efficiency and resource utilization through automation and lower energy demand



Source: Henkel

Putting the last four initiatives together, warm formed aluminum process, the structural adhesive bonding process, isolated clinch nuts and fasteners, and thin film coatings enables the use of an aluminum intensive door system, while still preserving the steel hinge systems. This drives the potential weight of the door-in-white being studied now down to below 16 kgs as shown in Figure 29.

Figure 29: Door Weight from 5 Parts Based on Material (Al,Al,Al,Al,ST)

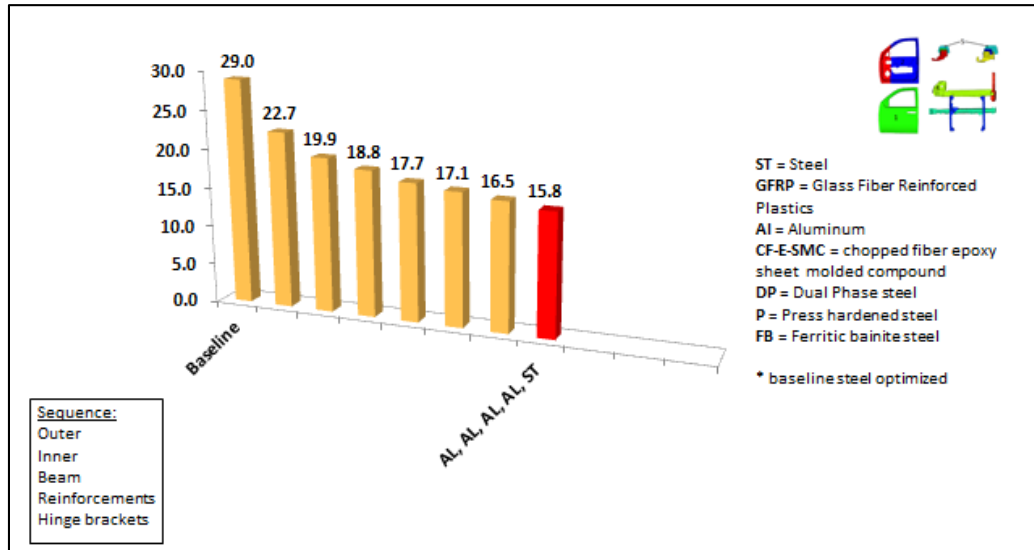

At this point in the development of alternative solutions, the CALM Team brought focus to the application of carbon fiber reinforced polymers (CFRP). Historically, this material was considered applicable only in the smallest of volumes, and reserved for use on exotic, high performance vehicles. It has been used for years in the development of monocoque bodies for race cars, where the laborious process of laying up a “one-off” design to produce a singular optimized structure with a combined body and chassis was the goal. The next step demonstrated by the auto industry witnessed the application of this material to higher volume, but still restricted to exceptionally low volume, high-end performance vehicles, as shown in Figure 30.

Figure 30: Carbon Fiber Applications Historically

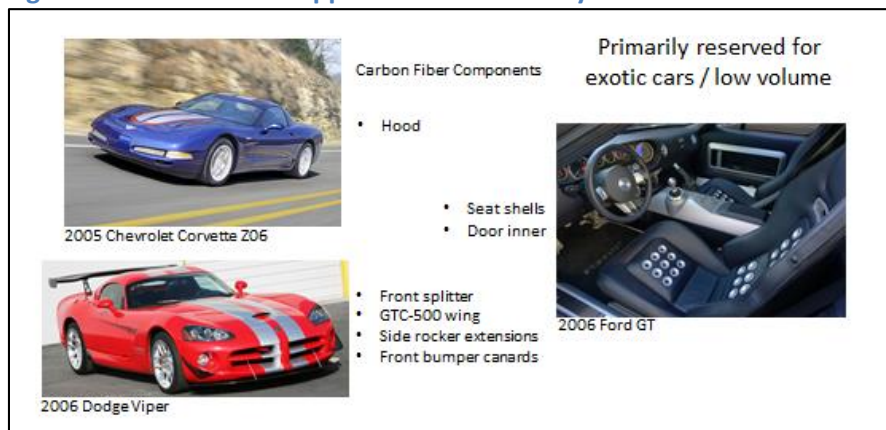

Source: CAR

CALM member companies such as Dow Automotive, Faurecia, and Hexion have all led developments in new CFRP materials as shown in Figure 31. These materials allowed customization of the interface between the carbon fiber and the resin, allowing developments tailored to automotive applications.

Figure 31: Carbon Fiber Spindles

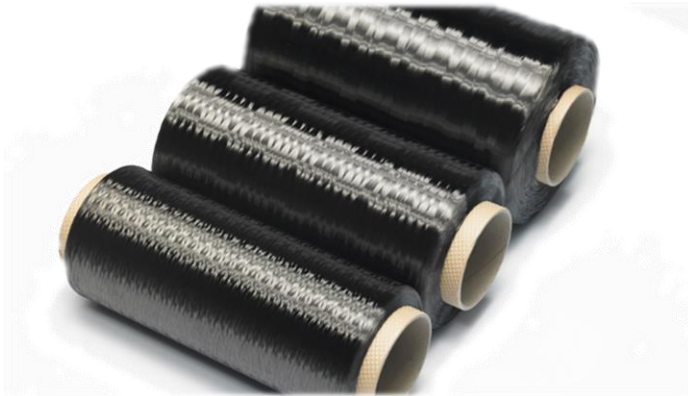

Source: Dow Automotive

These new materials are driving the demand for new forming and processing technology developments, to address the initial higher cost for these applications. AP&T, described previously as a developer of the warm forming for aluminum, drove process cycle times below two minutes by applying their systems to the production forming of CFRP. An example demonstrating this process is shown in Figure 32.

Figure 32: A-SMC Components Formed in Less than 2 Minutes



Source: AP&T

These newer developments in automotive CFRP, along with more standard part forming processes, bring the total weight for the door system to 14.5 kilograms by substituting a continuous fiber carbon fiber door outer to the assembly (Figure 33).

Figure 33: Door Weight from 5 Parts Based on Material (Cont. CF,GFRP,Al,GFRP,ST)

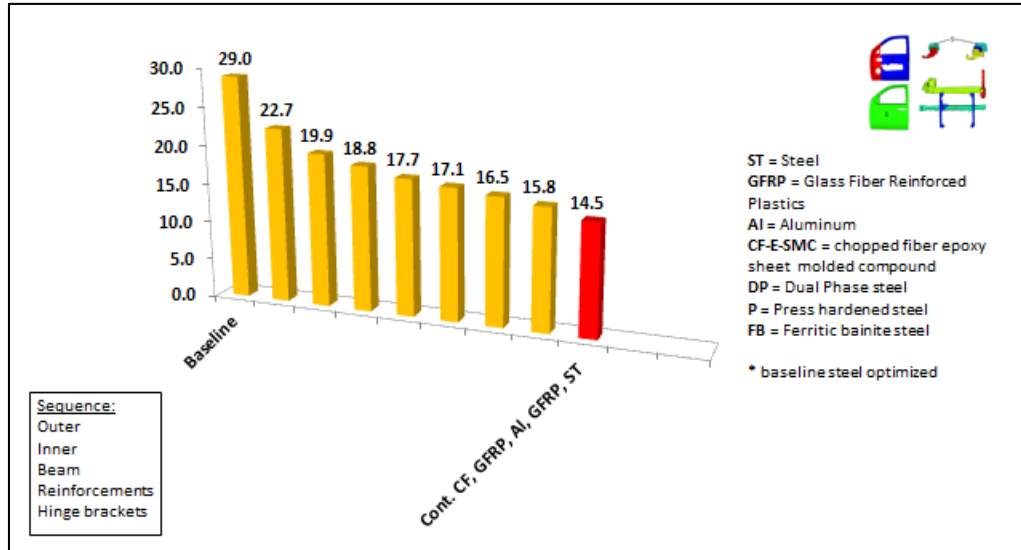
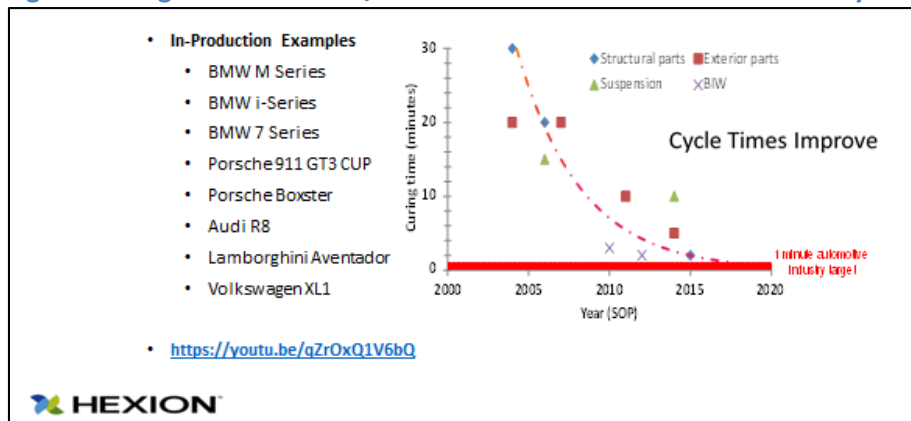

Figure 34 demonstrates the reduction in process times over the last ten years.

Figure 34: High-Pressure RTM/LCM Process' Continued Reduction in Cycle Times



Source: Hexion

This dramatic reduction in process times from approximately twenty minutes per part to now near one minute allows for a significant expansion in use of CFRP in future vehicles. Figure 35 further demonstrates this in the following picture of a door inner and outer assembly produced in carbon fiber.

Figure 35: Carbon Fiber Reinforced Polymer Door

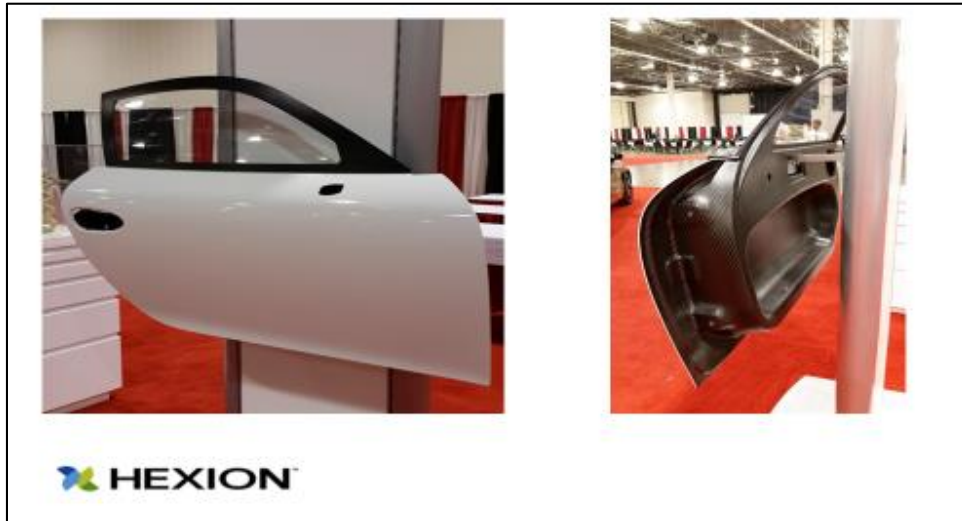

Source: Hexion

The BMW I3 took a significant step in the use of carbon fiber for structural applications. Up to this point, CFRP was typically reserved for specialty vehicles, performance vehicles, and for parts and applications where the CFRP served as a marketing tool. For example, vehicles having an after-market CRFP hood assembly were often left unpainted, to feature the use of what was considered an exotic material.

Recent developments in the expansion of CFRP drove the growth of chopped fiber, helping to dramatically reduce the cycle time for making parts and components. Since these were not considered class-A or exposed panels, the chopped fiber CFRP was acceptable as a material for the vehicle structure, where its inherent strength characteristics could be exploited for reducing weight from the structures.

In the case of the BMW I3, as shown in Figure 36, it was necessary for BMW to reduce the weight of the vehicle to compete with a standard 3-series vehicle. The use of CFRP for the structure enabled the company to offset the weight of the heavy batteries. This weight reduction increased the range of the electrically-driven vehicle, as it did not have the expected liability of additional weight from the batteries.

Figure 36: Carbon Fiber Application Progression (BMW i3)



Source: BMW

These developments in chopped fiber CFRP for non-exposed panels, along with the process developments to reduce cycle times led to a door system of 12.2 kilograms, with a CFRP door inner and beltline reinforcement. This result is shown in Figure 37.

Figure 37: Door Weight from 5 Parts Based on Material (GFRP,CF E-SMC,Al,CF E-SMC,ST)

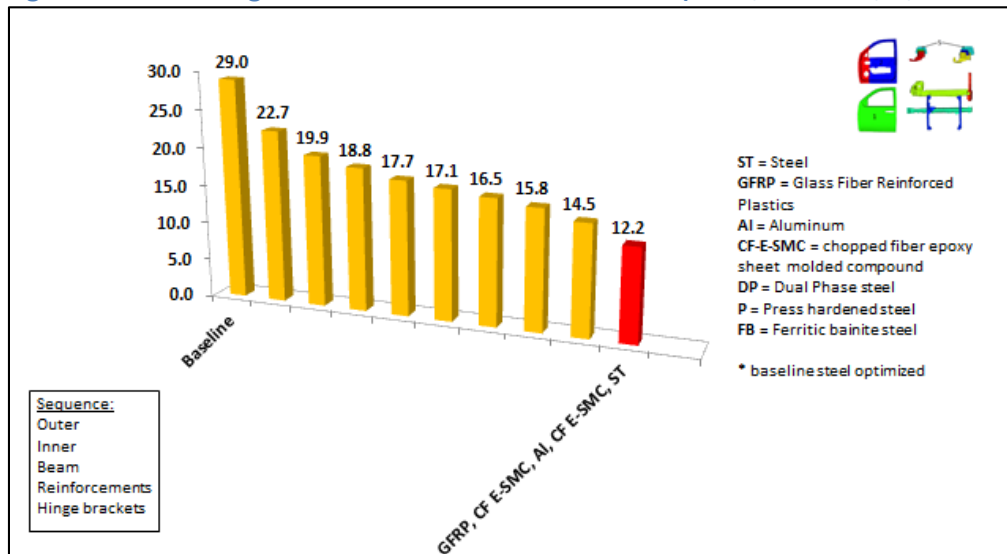

Additional developments in the application of CFRP “sandwiched” between metallic components brought another significant weight reduction opportunity. Just as BMW broke new ground with their application for structural underbody applications with the I3, BMW is demonstrating the highest volume applications to date for the BMW 7-Series, as shown in Figure 38. They are sandwiching CFRP into hollow spaces as in the A pillar along the windshield, and also applying CFRP to hidden reinforcement panels. These applications change the paradigm of reserving CFRP for only the lowest volume vehicles, as the 7-Series is planned for 80,000 annual production, with tooling systems capable of up to 100,000 volume.

Figure 38: Carbon Fiber Application Expansion (BMW 7-Series)



Source: BMW

These new applications for CFRP allowed a reduction in weight for the door system to just below 12 kilograms, as shown in Figure 39. This door assembly would maintain a glass fiber door outer panel, with a continuous fiber CFRP door inner, an aluminum intrusion beam along with a chopped fiber epoxy resin beltline reinforcement panel. As with all other examples, the CALM Team left the steel hinges intact as originally designed.

Figure 39: Door Weight from 5 Parts Based on Material (GFRP, Cont. CF, Al, CF E-SMC, ST)

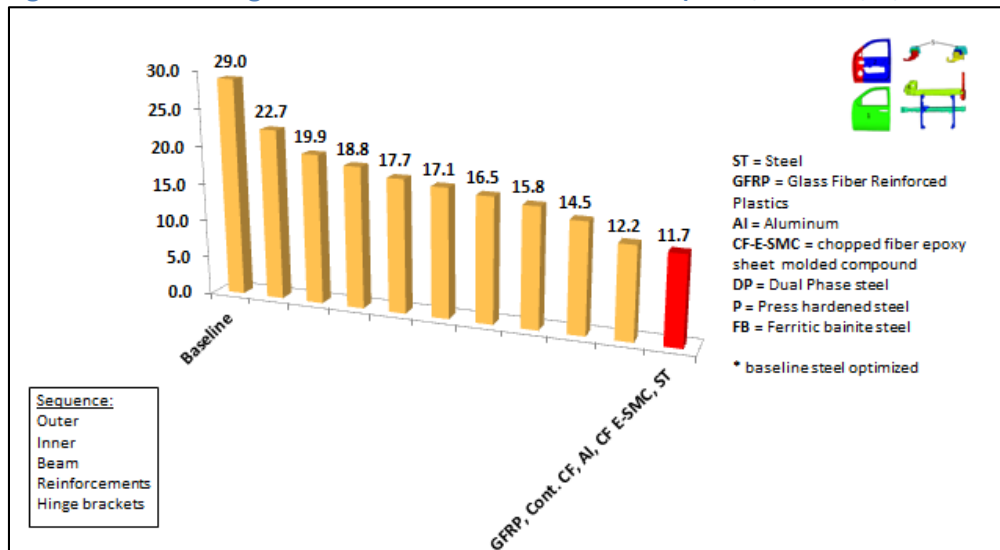

An additional development to enable to the use of CFRP in cavity areas, such as in the A-Pillar structure is the use of injected structural adhesives. These adhesives not only hold the insert in place, they act as a sound deadener as well as add to the structural reinforcement of the vehicle. Several members of the CALM Team have similar structural adhesives in production and available for customization in new vehicle designs. An example of an application for this injected structural adhesive is show in Figure 40.

Figure 40: CFRP A-Pillar Insert Supported by Injected Structural Adhesive (Dow BETAFORCE™)

Advantages

- Body Shop or Trim Shop solutions
- Steel intensive, aluminum intensive, carbon fiber intensive or multi material construction
- Enhances body stiffness and durability
- Enables down-gaging of metals and reduction of spot welds



Dow BETAFORCE™ injection bonding example showing carbon fiber core and metal housing







Source: Dow Automotive

Aside from a structural adhesive, CALM member companies also produce structural foam products. These enable the reduction in the use of carbon elements to save weight. An additional benefit from the use of structural foam is its inherent sound deadening capability. An example of the use of structural foam is shown in Figure 41.

Figure 41: Structural Foam (Dow BETAFOAM™)





Dow BETAFOAM™

Advantages

- Potential to reduce level of carbon fiber in the composite or down-gage metal by leveraging reinforcement contribution of structural foam
- Acoustical performance can be improved with foam



Source: Dow Automotive

Shown in Figure 42 is an example of how these products work together as a system. The carbon fiber material itself, along with the structural adhesives, resins and foam apply together as a system, enabling significant weight reduction while enhancing the overall strength of the assembly.

Figure 42: Four Enablers Integrate into a Single Assembly

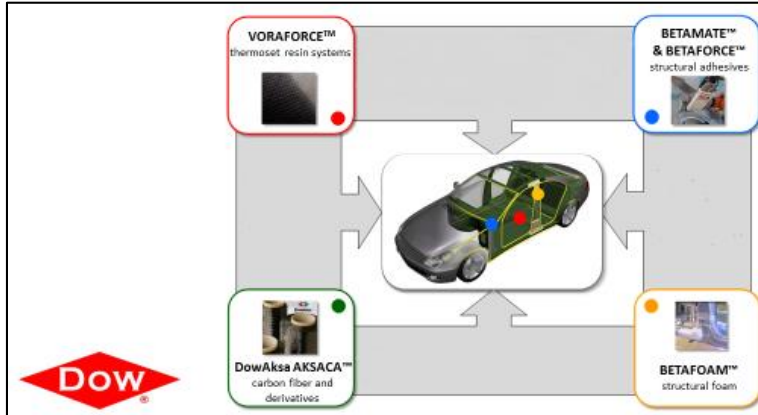

Source: Dow Automotive

All these enablers for carbon fiber applications taken together and applied to the door assembly being studied drive an assembled weight of 9.7 kilograms, the lowest weight in the study (Figure 43).

Figure 43: Door Weight from 5 Parts Based on Material (Cont. CF, Cont. CF, AI, CF E-SMC, ST)

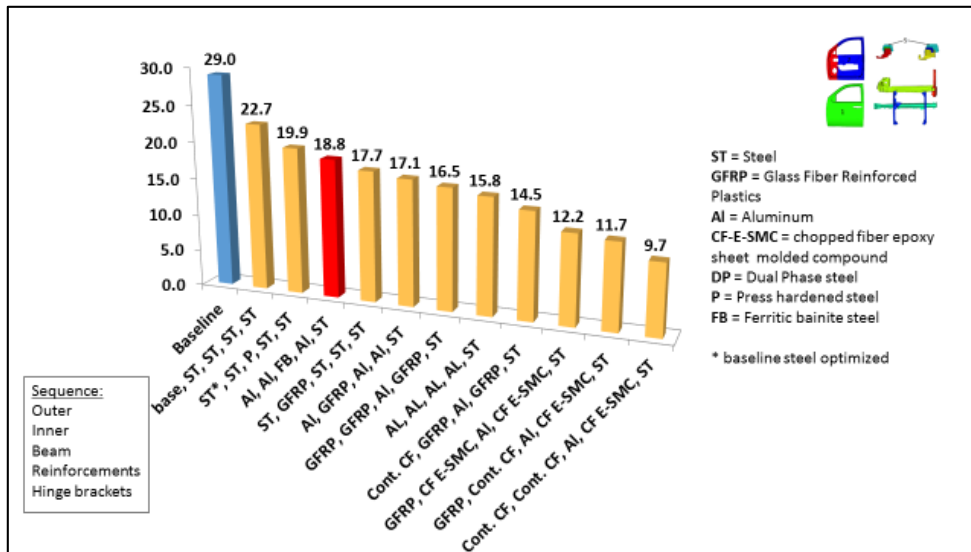

Additional Future Developments

Other Advanced Considerations

Beyond the enablers displayed and demonstrated in the previous sections, the CALM Team raised several other ideas more appropriate for future development work. Up to this point, every enabler shown can be demonstrated to already be in production in some location. These next concepts and ideas would require close developmental work between specific companies and the OEMs interested in the concepts. Although significant developmental work is already underway at several of the participant companies, these future concepts require specific applications for validation and completion.

The first future development concept presented by SABIC is for a thermoplastic sealed door module. Although the Team reviewed this concept in light of a weight reduction effort, this concept has the added benefit of part consolidation. Not only is the idea a potential weight savings for the assembly, it also would require fewer parts to assemble with a potential cost reduction as an additional result. This translatable technology is available today, and can be used regardless of the selection of door structure materials. An example of this concept is shown in Figure 44.

Figure 44: Thermoplastic Sealed Door Module (Advanced Consideration)



Source: SABIC

The use of polycarbonate material to replace glass is already the norm in the aerospace industry. Several CALM member companies produce polycarbonate materials, and each would be open to working with an OEM to produce a replacement for glass either in the passenger cabin or in the lighting of the future vehicle. Polycarbonate material is finding its way into concept cars and trucks already, as can be seen in Figure 45.

Figure 45: Polycarbonate Glazing (Advanced Consideration)



Source: CAR

The Aluminum Transportation Group also presented the idea of a breakthrough in micromill technology for re-cycling and producing aluminum. This brings an OEM the capability of establishing a lower cost, closed loop system, and enables production of higher material strength aluminum with enhanced forming characteristics. This solution has already been implemented by at least one automaker (Ford F-150). While the Ford F-150 is the only vehicle produced on its production line, addition development work will enable similar results in a multi-product assembly plant (Figure 46).

Figure 46: Alcoa Micromill™ (Advanced Consideration)

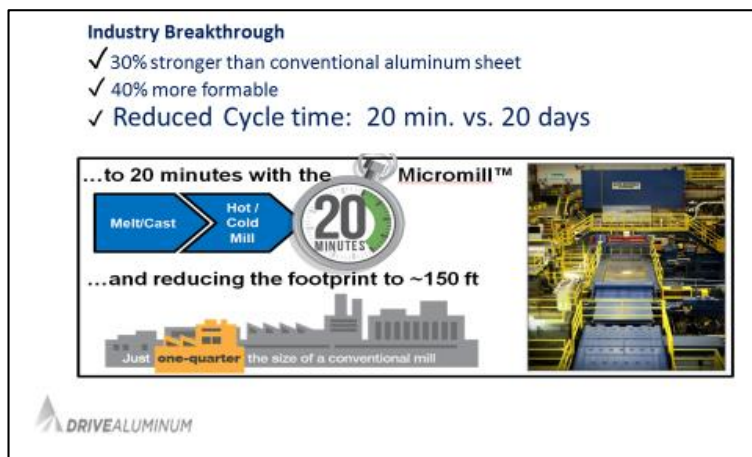

Source: Drive Aluminum

An additional development from the Aluminum Transportation Group is the development of higher strength 7000 series material. This material is the basis for the warm forming aluminum process described earlier in the enablers section. This is now available in a wide range of material gages, and can be applied now to future vehicles (Figure 47).

Figure 47: Novelis Advanz 7000-Series Aluminum (Advanced Consideration)

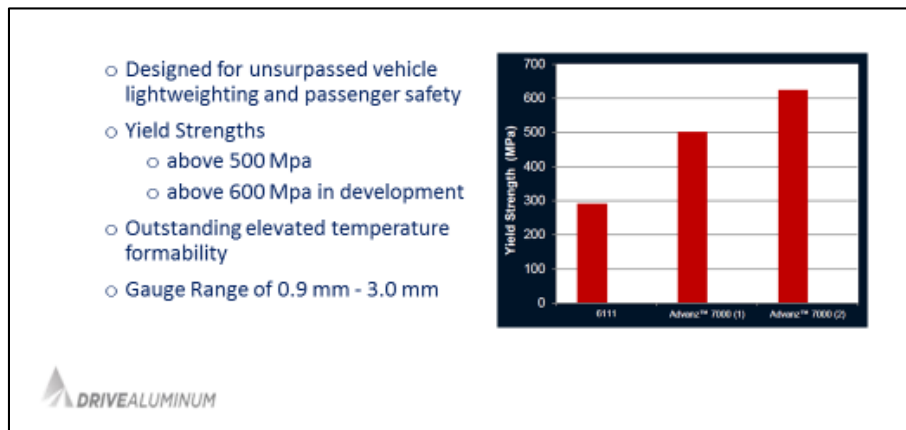

Source: Drive Aluminum

Although the Team looked at some earlier examples of curvilinear blanks in the enablers section, Shiloh Industries brings the concept, shown in Figure 48, of deploying this technology in a way to consolidate panels, not only a way of reducing weight of existing laser welded blanks. This reduces weight, and eliminates sets of tooling for the consolidated parts. Assembly cost also is reduced with part consolidation.

Figure 48: Curvilinear Laser Welded Blanks (Advanced Consideration)

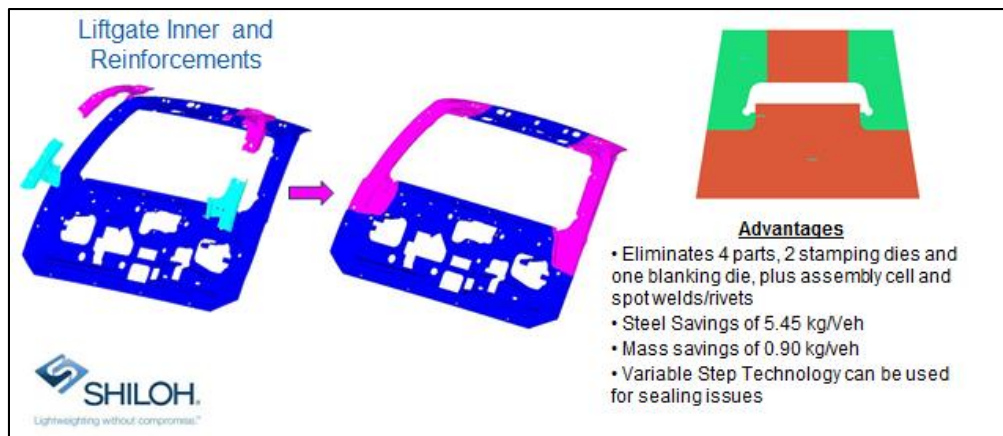

Source: Shiloh

The steel industry continues to develop higher strength solutions to be applied in new vehicles. The newest developments increase formability while increasing strength. Examples are shown in Figure 49.

Figure 49: Innovation in AHSS

- **Coated Bake Hard 440** provides light weighting opportunities for **surface-critical applications**
- **Next Generation AHSS 1000 and 1200** with improved elongations over Dual Phase steels with equivalent strength
- **NITRONIC[®] 30** existing stainless steel grade with optimized cost, good formability, high strength, corrosion resistant and premium surface finish
- **NanoSteel NXG™ 1200** 3rd generation AHSS, for high strength and great formability in multiple applications
- Collaborative research on **Joining Technology**

SAFETY | QUALITY | PRODUCTIVITY

AKSteel

Source: AK Steel

The final concept to review in this future development section is a concept from Dupont (Figures 50a and 50b). The concept is a structural hybrid door inner merged with the inner trim panel as a single, composite panel. The increased depth, or cross section provides additional stiffness and rigidity. This is only a concept at this point, and would require co-development working directly with an OEM. It is yet another idea for consolidating parts and eliminating individual tooling sets while reducing weight.

Figure 50a: Structural Hybrid Door Inner (Advanced Consideration)

- The trim panel is integrated into the structural inner panel (traditionally steel) using *Vizilon™* continuous glass reinforced thermoplastic composite.

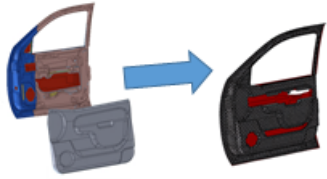

- This part integration allows the surfaces to be further apart, increasing the moment of inertia, which increases the stiffness of the assembly.

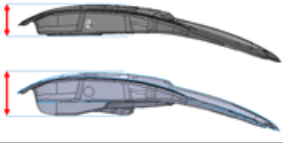



Source: DuPont

Figure 50b: Structural Hybrid Door Inner (Advanced Consideration)

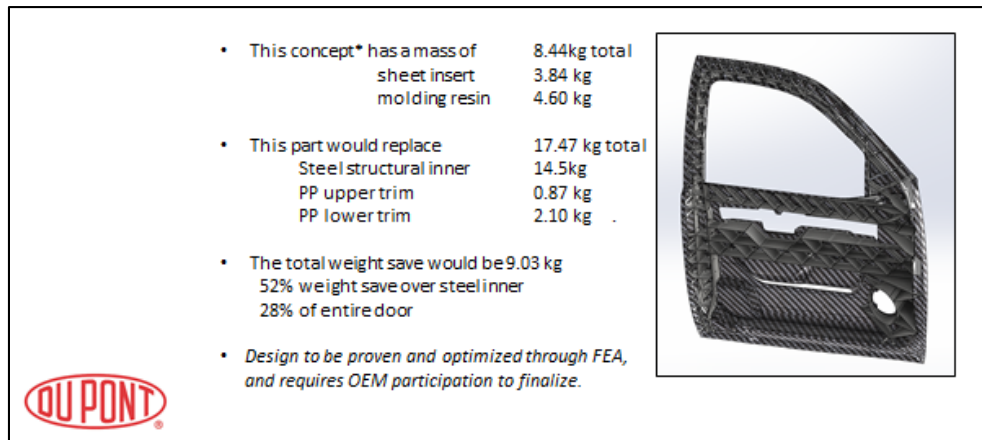

Source: DuPont

Summary

To summarize, the CALM coalition of companies identified a dozen combinations of initiatives and concepts bringing a potential weight reduction up to 65 percent.

The Team knows every automaker is aggressively working on reducing weight to help attain the emissions and fuel consumption regulations. The Team also knows as the OEMs move up the curve and investigate more aggressive materials for weight reduction, capacities are more constrained. However, volumes up to 100,000 per year are in production now, using the most aggressive materials and processes known.

The CALM members continue to develop new materials, applications and processes, as shown in the few advanced concepts for considerations. Individual participating members are listed in the addendum of this paper for the purpose of facilitating any feedback necessary.

Figure 51: The Results

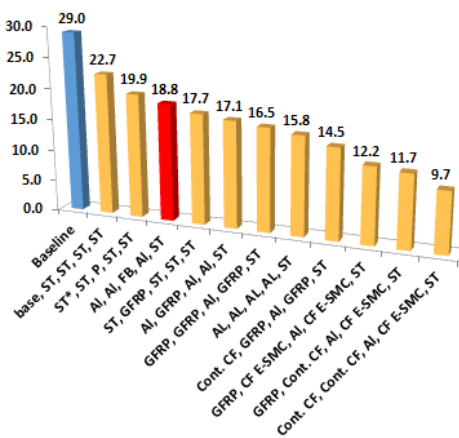

Bibliography

- Altair Engineering Inc. (n.d.). *Overcoming the Challenges of Composite Design through Simulation*.
- Aluminum Association Inc. (n.d.). *Aluminum Processes and Materials*. Retrieved August 29, 2012, from AluminumTransportation.org.
- Amos, S. (2012, August 29). Reducing Vehicle Weight While Maintaining Vehicle Safety: The Role of Plastics.
- Carpenter, J. A. (2008). *Challenges to Automotive Composites*. Arlington, VA: American Chemistry Council - Plastics Division.
- Ducker Worldwide. (2011). *Aluminum in 2012 North American Light Vehicles*. The Aluminum Association, Inc.
- Ducker Worldwide. (2011). *American Iron and Steel Institute - SMDI Light Vehicle Steel Content*. Steel Market Development Institute.
- ELM. (2010, March 30). *ELM Supplier Database*.
- Grabener, L. (2011). Forming of fiber reinforced plastics with presses of Schuler SMG. *Schuler Incorporated Symposium*.
- Husman, G. (n.d.). Low Cost Carbon Fiber Materials and Processing Technologies. *SAE International*.
- MarkLines. (2012, August 29). *MarkLines Supplier Database*. Retrieved from MarkLines Web Site: http://www.marklines.com/en/supplier_db/
- Momentive Specialty Chemicals Inc. (2012). Accelerating Energy Efficiency, Safety, and Comfort: Innovative Resin Solutions for Automotive Manufacturing.
- Parsons, C. (2012). Innovation and Globalization as Factors of Success for Automotive Lightweighting. *2012 Center for Automotive Research Management Briefing Seminars*. Traverse City.
- Rocky Mountain Institute. (2012). *Autocomposites Draft*.
- Schutte, C., & Joost, W. (2012). *Lightweighting and Propulsion Materials Roadmapping Workshop Outbrief*. U.S. Department of Energy Vehicle Technologies Program.
- Singh, H. (2012). Economic lightweighting options for high volume production vehicle structures for year 2020. *Great Designs in Steel*. EDAG, Inc.
- USCAR. (2008). *The Power of Automotive Collaboration U.S. Government/USCAR R&D Successes*.
- USCAR. (n.d.). *Magnesium Vision 2020: A North American Automotive Strategic Vision for Magnesium*.

Warren, D. C. (2008). *Carbon Fiber Development in the Automotive Lightweighting Materials Program*. Oak Ridge National Laboratory.

World Auto Steel. (2009, March). *Advanced High Strength Steel (AHSS) Application Guidelines 4.0*. Retrieved September 7, 2012, from WorldAutoSteel.org .

Wyzgoski, M. G. (2012). American Chemistry Council Predictive Engineering Activities. *SAE International*.

Zuidema, B. (2012, August 29). Steel Solutions for Reducing Weight While Maintaining Vehicle Safety.

Appendix A: Automotive Materials, Applications and Processes

Aluminum		
Material Designation	Application	Forming Process
2000 Series	Outer/Inner Body Panels, Load Floors, Seat Shells, Fasteners	Stamping
3000 Series	Interior Panels, Radiator Tubes, Heater & Evaporator Fins, Condenser Tubes, Oil Coolers	Extrusion
4000 Series	Cladding for Brazing Sheet, Forged Pistons	Stamping
5000 Series	Inner Body Panels, Splash Guards, Heat Shields, Air Cleaner Tryas & Covers, Structural & Weldable Parts, Load Floors, Wheels, Engine Brackets	Stamping
6000 Series	Outer & Inner Body Panels, Load Floors, Bumper Reinforcements, Structural & Weldable Parts, Seat Shells, Suspension Parts, Driveshafts, Brake Housings	Extrusion, Stamping, Forging
7000 Series	Seat Tracks, Bumper Reinforcements, Condenser & Radiator Fins, Headrest Bars	Stamping, Extrusion
319	Manifolds, Cylinder Heads, Blocks, Internal Engine Parts	Casting, Forging
332	Pistons	Casting, Forging
356	Cylinder Heads, Manifolds	Casting
A356.0	Wheels	Casting
A380.0	Blocks, Transmission Housing/Parts, Fuel Metering Devices	Casting
383	Brackets, Housings, Internal Engine Parts, Steering Gears	Casting
B390.0	High-wear Applications, Ring Gears, Internal Transmission Parts	Casting, Forging

Appendix A: Automotive Materials, Applications and Processes (continued)

Polymers/Composites		
Polymers		
Material Designation	Applications	Forming Process
Thermoplastics	Grill Opening Reinforcement, Bumper Fascia, Headlights, Trim, Instrument Panels, Steering Wheels, Load Floor, Seat Bases	Molding
Thermosets	Air Intake Manifold, Trim, Spoilers, Front-end Grill Panel, Battery Casings, Headlamp Housing, Bumper & Bumper Beam, Heat Shields, Cylinder Head Covers	Molding
Elastomers	Hoses, Seals, Belts, Gaskets	Extruding, Molding
Composites		
Material Designation	Applications	Forming Process
Fiber-Reinforced Composite	Hood, Bumper Beam, Fender, Floor Board, Door Inner, Rear Deck Lid, Roof, Body Panels, Monocoque Structure	Sheet Molding
Structural Composite	Horizontal Body Panels	Sheet Molding

Magnesium		
Material Designation	Application	Forming Process
AZ91D	Oil Pan, Drive Brackets, Steering Column Brackets, Transmission Case, Crankcase, Steering Box	Die Cast
AZ91E	Engine Valve Cover, Wheels	LPDC
AM60	Instrument Panel, Front-end Structure, Seat Frame, Wheels, Radiator Support	LPDC
AM-SC1 (Prototype)	Engine Block, Transmission Housings	Die Cast
AE42/AS41/AS21	Automatic Transmission Case	Die Cast
AC63/ZE41	Engine Blocks	Die Cast













Appendix A: Automotive Materials, Applications and Processes (continued)

Steel		
Material Designation	Application	Forming Process
Mild Steel (tensile strengths less than 295 MPa)	Closures, Bumpers	Cold Stamping
HSS (210 MPa to 550 MPa) (including: HSLA, BH, and, CMn)	Door Inners, Bumpers, BIW, Wheels, Fuel Tank	Stamping, Press Hardening
AHSS	Door Structures, Front Rails, Roof Reinforcements, Waistline Beams, Side Rail Reinforcements, ABC Pillars	Cold Stamping

Appendix B: Coalition for Automotive Lightweight Materials - Contributors















Contributing and Participating Company Representatives

Aisin, Inc. -----		Christophe L. Gaillard	(734) 582-5381	cgaillard@aisintca.com
AK Steel Corp. ----- PHS1500 side impact beam; DP980 belt outer reinforcement; DP440 BH door outer		Dr. P.K. Rastogi	(313) 317-6362	prabhat.rastogi@aksteel.com
Altair Engineering, Inc. -----		Richard Yen	(248) 614-2400	sry@altair.com
The Aluminum Association ----- Extruded aluminum impact beams		Doug Richman	(248) 860-8100	doug.richman@kaiserai.com
American Chemistry Council -----		Gina-Marie Oliver	(248) 244-8920	Gina-Marie_Oliver@americanchemistry.com
AP&T ----- PHS1500 side impact beam; aluminum hot forming; < 2 min cycle time for A-SMC		Adam Allansson	(704) 953-0940	adam.allansson@aptgroup.com
ARaymond -----		Ryan Everett Ward	(248) 369-1900	Ryan.Ward@araymond.com
Axalta Coating Systems -----		David Fischer	(586) 789-6507	david.a.fischer@axaltacs.com
BASF Corp. ----- Body paint treatment; structural adhesive; LASD; thin film surface treatment; structural foam		Rob Lyons	(248) 370-0866	robert.lyons@basf.com
Bollhoff, Inc. -----		Steve Paddock	(248) 766-1247	spaddock@bollhoff.com
Covestro, LLC -----		Bruce C. Benda	(412) 413-2280	bruce.benda@covestro.com
Dana Holding Corp. -----		Eve S. Steigerwalt, Ph.D.	(731) 231-1269	eve.steigerwalt@dana.com
Dow Automotive Systems ----- Body paint treatment; structural adhesive; LASD; thin film surface treatment; CFRP; thermoset resin; structural foam		John Lemanski	(248) 391-6582	John.Lemanski@dow.com

Appendix B: Coalition for Automotive Lightweight Materials – Contributors (continued)



Contributing and Participating Company Representatives

DuPont Performance Polymers ----- 	Janet Sawgle	(248) 684-8824	janet.m.sawgle@dupont.com
Body paint treatment; structural adhesive; woven GFR nylon; structural hybrid door inner			
Eisenmann Corp. ----- 	Chris Kane	(815) 455-4100	chris.kane@eisenmann.com
Faurecia Automotive Exteriors ----- 	Yang Cao	(248) 409-5159	yang.cao@faurecia.com
Composite solutions for multi-material components; CFRP; thermoset resin; polycarbonate glazing			
Henkel, Inc. ----- 	Kevin Wook	(248) 589-4642	kevin.woock@henkel.com
Body paint treatment; structural adhesive; LASD; thin film surface treatment; structural foam			
Hexion, Inc. ----- 	Cedric Ball	(614) 225-2076	cedric.ball@momentive.com
CFRP; thermoset resin; polycarbonate glass			
ITW Automotive ----- 	James Kirchen	(715) 720-3294	jkirchen@deltarfasteners.com
Pittsburgh Glass Works, LLC ----- 	Paolo Cavallari	(248) 218-8022	pcavallari@pgwglass.com
PPG Industries, Inc. ----- 	Jim Ohlinger	(330) 284-1690	ohlinger@ppg.com
Body paint treatment; structural adhesive; thin film surface treatment; structural foam; polycarbonate glazing			
Rifast Systems, LLC ----- 	Jim Erhardt	(847) 933-8582	jerhardt@rifastllc.com
Clinching products			
SABIC ----- 	Matthew Marks	(248) 926-4207	matthew.marks@sabic.com
Thermoplastic sealed door module; polycarbonate glazing			
Shiloh Industries, Inc. ----- 	Jonathan Fisk	(734) 354-3132	jonathan.fisk@shiloh.com
Curvilinear laser welded blanks			
Sika Corp. ----- 	Kent Fung	(248) 577-1037	fung.kent@us.sika.com